



**CIRCULAR Nº 034/24**

**ASSUNTO:** Campeonato AS Nacional Juniores 2024 - RESULTADOS

Odivelas, 10 de março de 2024

Exmos. Senhores,

Vimos por este meio proceder à divulgação dos resultados do Campeonato AS Nacional Juniores 2024.

<b>PROVA</b>	<b>Campeonato AS Nacional Juniores 2024</b>
<b>DATA/LOCAL</b>	Sábado 2 de março de 2024, Pavilhão Municipal de Albufeira
<b>ESCALÃO</b>	Juniores Masculinos e Femininos
<b>Nº ATLETAS</b>	141 Atletas Masculinos + 78 Atletas Femininos = 219 Atletas (72 clubes)

**RESULTADOS FINAIS**

**MASCULINOS**

<b>-60KG (33 atletas)</b>			<b>-66KG (35 atletas)</b>		
1º Daniel VIEGAS	130863	CNSu	1º Gonçalo LAMPREIA	137419	SCP
2º Daniel SANTOS	141569	JCPPr	2º Leonardo RABAÇAL	181263	ULHT
3º Manuel FIGUEIREDO	151797	CNSu	3º Francisco CARAVANA	156573	SCP
3º Martim NICOLA	125633	CNFC	3º Tomás FONSECA	136526	SCP
<b>-73KG (32 atletas)</b>			<b>-81KG (23 atletas)</b>		
1º Henrique FERREIRA	137547	SCP	1º Filipe ALMEIDA	138542	SUS
2º Gonçalo CABRAL	137202	ULHT	2º António ALMEIDA	131236	GCP
3º Júnior DUARTE	145930	SUS	3º Francisco PEREIRA	142342	EJC
3º André LOPES	123808	ULHT	3º Manuel BAPTISTA	129005	JCPt
<b>-90KG (12 atletas)</b>			<b>-100KG (2 atletas)</b>		
1º Diogo CHANTRE	124795	SAD	1º Max MAZYAR	137880	CNSu
2º Víctor ANTUNES	161650	A4JP			
3º Manuel MONGE	145978	SCP			
3º Lourenço PIMENTA	140177	SUS			



Federação Portuguesa  
de **Judo**

## mais do que um DESPORTO... um DESPERTAR!

INSTITUIÇÃO DE UTILIDADE PÚBLICA DESPORTIVA  
CONT N° 501 515 674  
MEMBRO DA UNIÃO EUROPEIA DE JUDO  
E DA FEDERAÇÃO INTERNACIONAL DE JUDO  
FUNDADA EM 1959



SEGUINDO A SUA POLÍTICA DE SUSTENTABILIDADE  
A FEDERAÇÃO PORTUGUESA DE JUDO  
PASSA DA ACREDITAÇÃO IMPRESSA PARA UMA VERSÃO ONLINE  
CONTANDO COM O APOIO DE TODA A FAMÍLIA DO JUDO

### +100KG (4 atletas)

1º João COITO	136210	JCSa
2º Henrique SOUSA	156336	JCLa
3º Manuel SERRA	139805	ULHT

## FEMININOS

### -48KG (10 atleta)

1º Inês FARIA	127721	SUS
2º Ana PACHECO	172707	CJRG
3º Mariana PEREIRA	157924	ADJF
3º Isabel FARIAS	145452	JCPD

### -52KG (16 atletas)

1º Iara GUEDES	134336	SUS
2º Maria XAVIER	157935	SAD
3º Mariana DIAS	127560	CJRI
3º Iracema MANARTE	129642	ADJF

### -57KG (15 atletas)

1º Raquel BRÁS	141492	SUS
2º Maria DIAS	153054	CRCh
3º Sofia PASSÃO	130435	JCPPr
3º Carlota PINA	139716	SCP

### -63KG (15 atletas)

1º Adriana TORRES	122248	EJAH
2º Matilde JOTA	146992	JCPPr
3º Leonor COSTA	153758	SAD
3º Mafalda SILVA	134353	JCRG

### -70KG (12 atletas)

1º Luísa SANTOS	175553	VFC
2º Beatriz ROSA	145296	JCPt
3º Isabel COSTA	140045	FSAL
3º Matilde ANALORY	177625	ACMC

### -78KG (2 atletas)

1º Fábria CONCEIÇÃO	138458	SUS
---------------------	--------	-----

### +78KG (8 atletas)

1º Rosa MANÉ	162835	JCAI
2º Ana SILVA	151941	Manh
3º Mariana NUNES	174109	ADJF
3º Constança LOPES	140183	SUS

Com os nossos melhores cumprimentos e cordiais,

Saudações Desportivas  
O Presidente da FPJ

Joaquim Sérgio Pina



Federação Portuguesa  
de **Judo**



(1/3)  
**CAMPEONATO AS NACIONAL DE JUNIORES**  
**ALBUFEIRA – 2 DE MARÇO DE 2024**  
**-60 Kg**

Competitors: 33

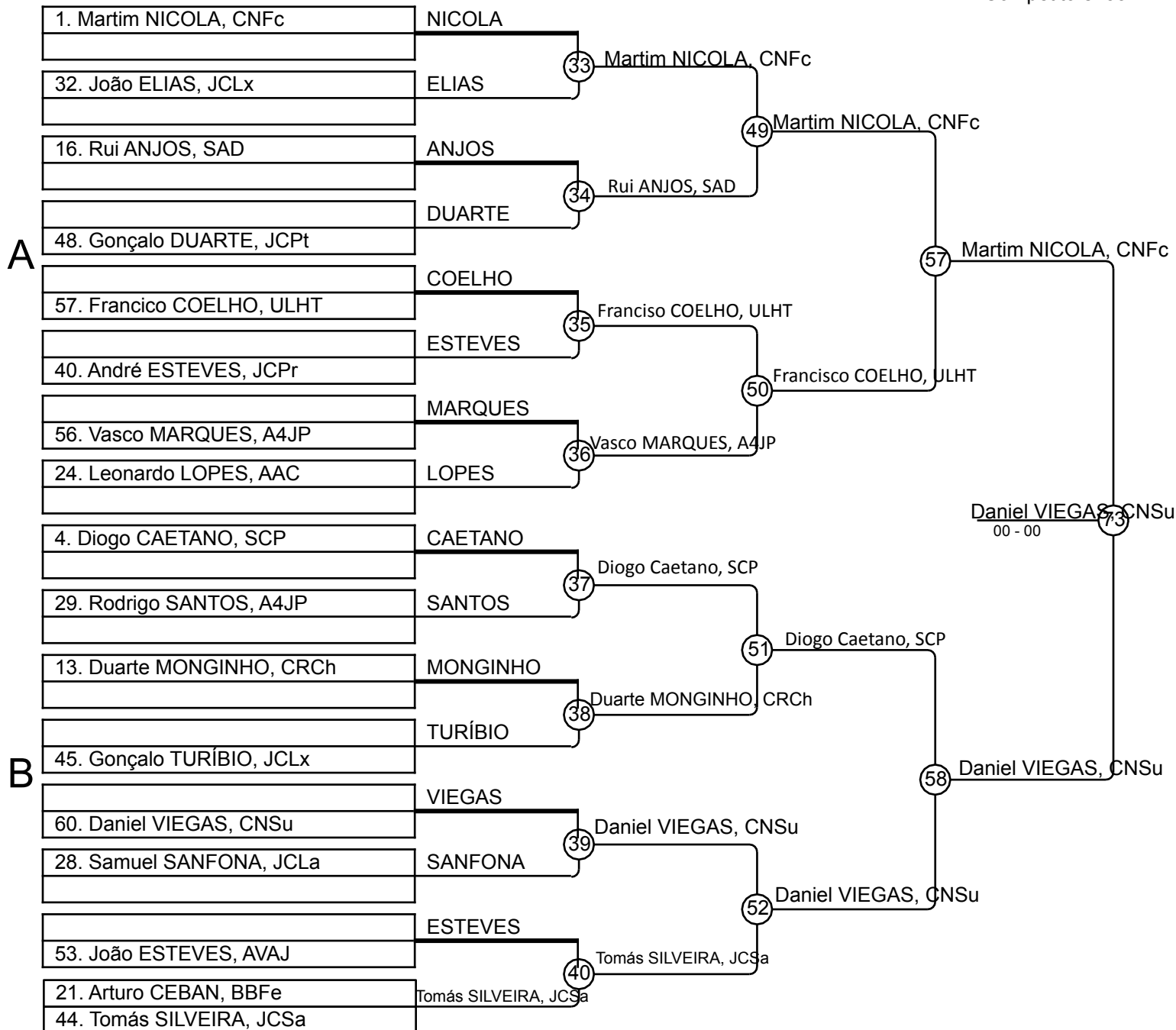

(2/3)

# CAMPEONATO AS NACIONAL DE JUNIORES

## ALBUFEIRA – 2 DE MARÇO DE 2024

### -60 Kg

Competitors: 33

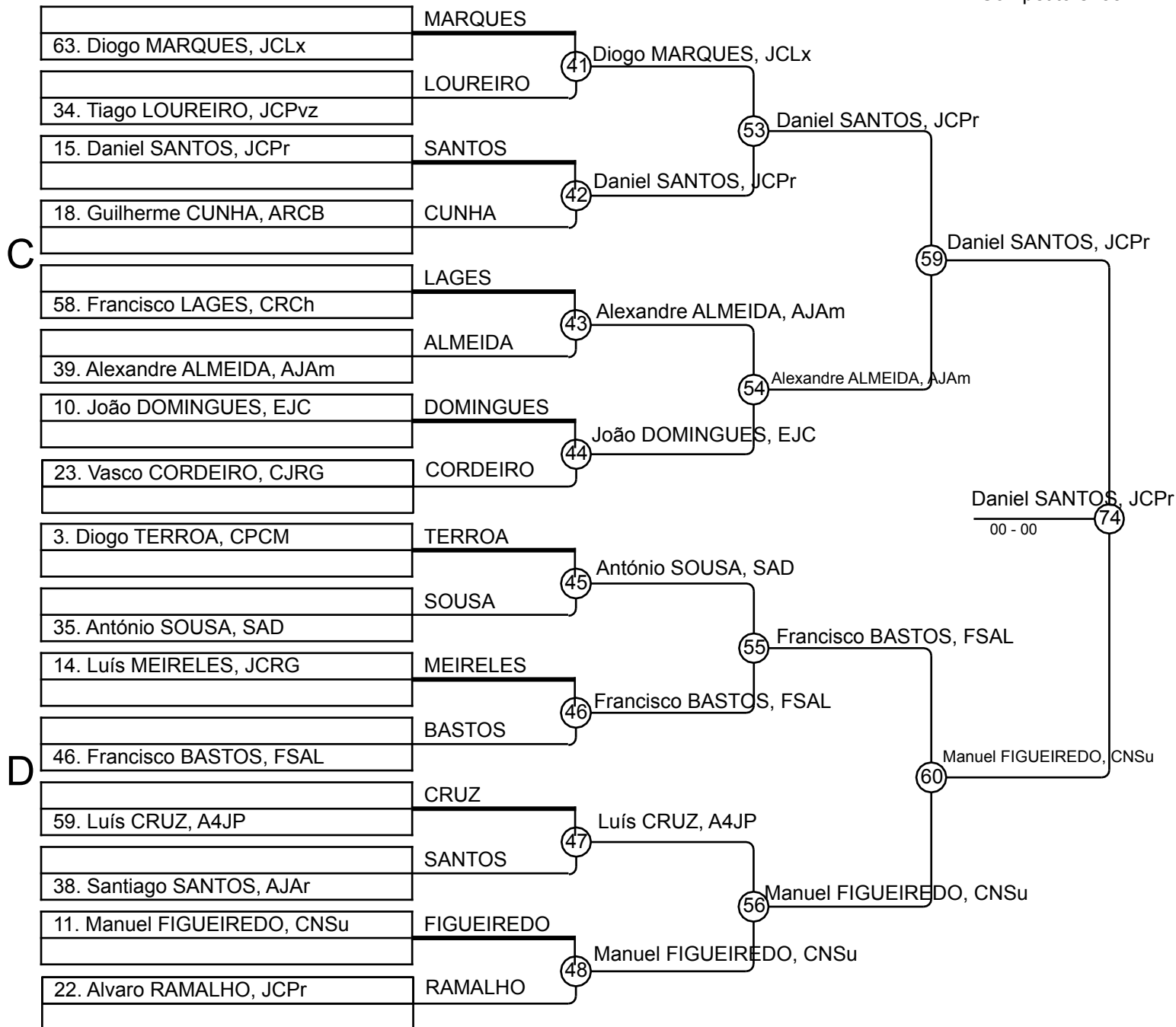

(3/3)

# CAMPEONATO AS NACIONAL DE JUNIORES

## ALBUFEIRA – 2 DE MARÇO DE 2024

### -60 Kg

Competitors: 33

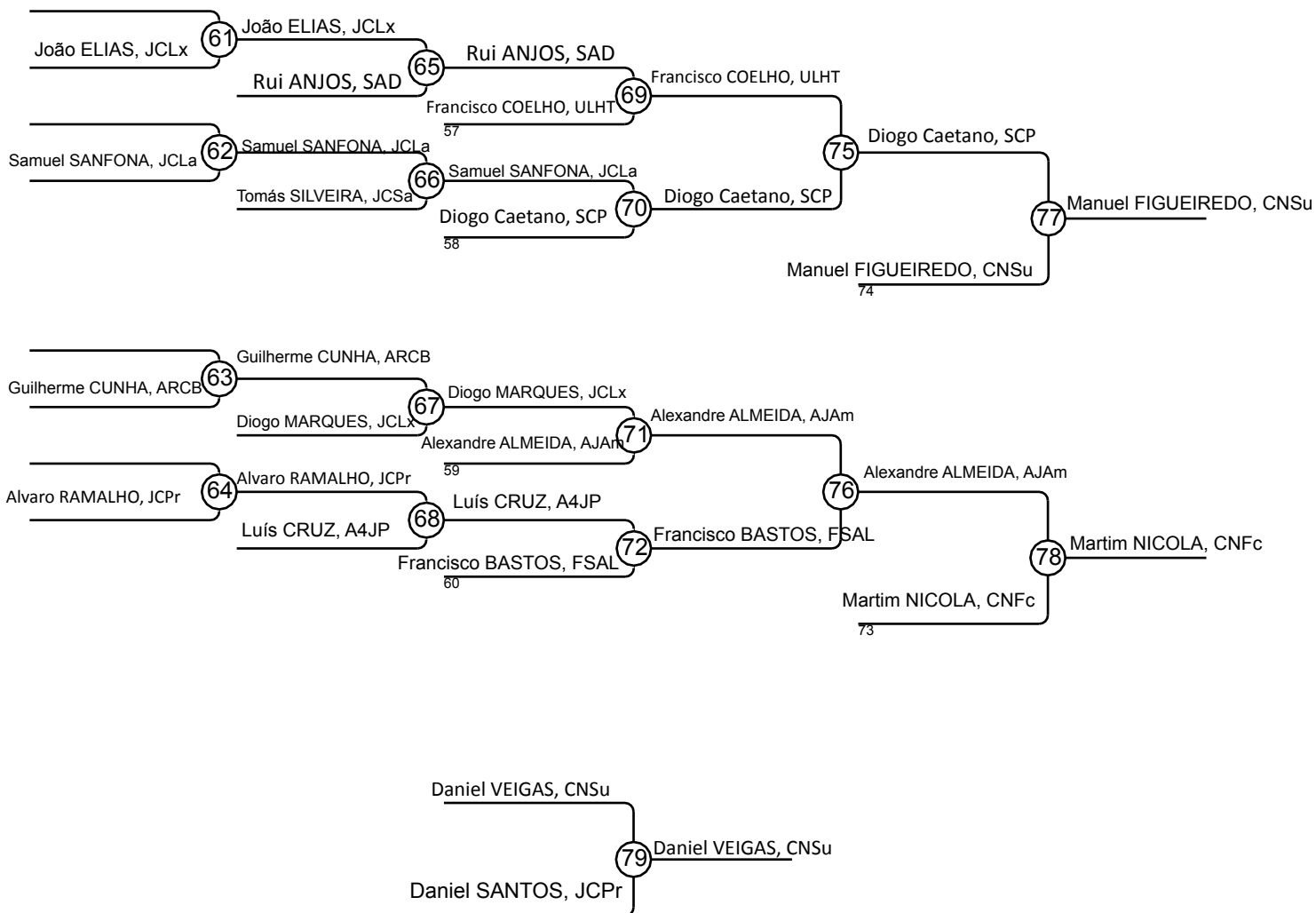

## Results

Pos	Name
1	Daniel VEIGAS, CNSu
2	Daniel SANTOS, JCPPr
3	Manuel FIGUEIREDO, CNSu
3	Martim NICOLA, CNFc
5	Diogo Caetano, SCP
5	Alexandre ALMEIDA, AJAm
7	Francisco COELHO, ULHT
7	Francisco BASTOS, FSAL

(1/3)  
**CAMPEONATO AS NACIONAL DE JUNIORES**  
**ALBUFEIRA – 2 DE MARÇO DE 2024**  
**-66 Kg**

Competitors: 35

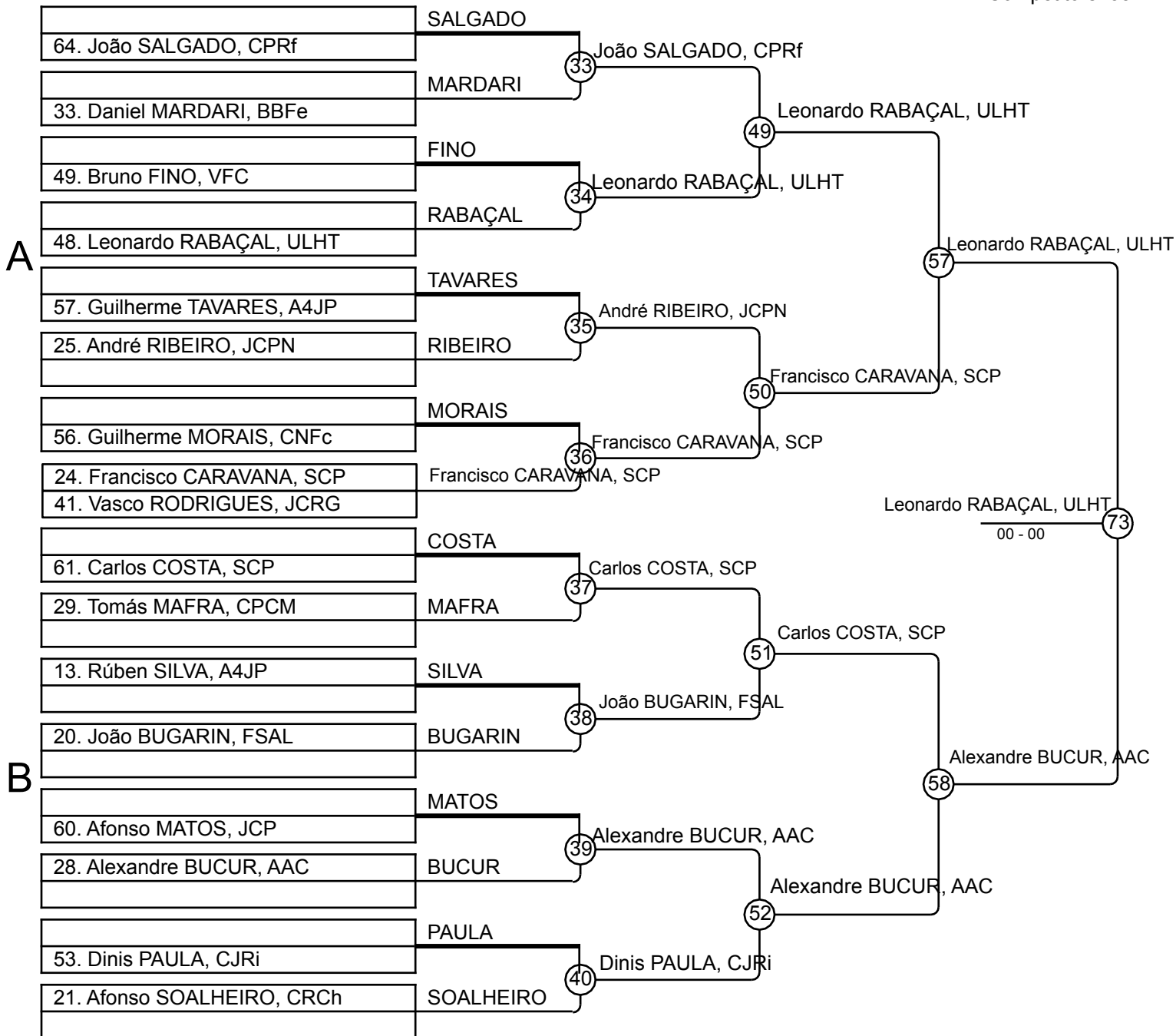

(2/3)  
**CAMPEONATO AS NACIONAL DE JUNIORES**  
**ALBUFEIRA – 2 DE MARÇO DE 2024**  
**-66 Kg**

Competitors: 35

**C**

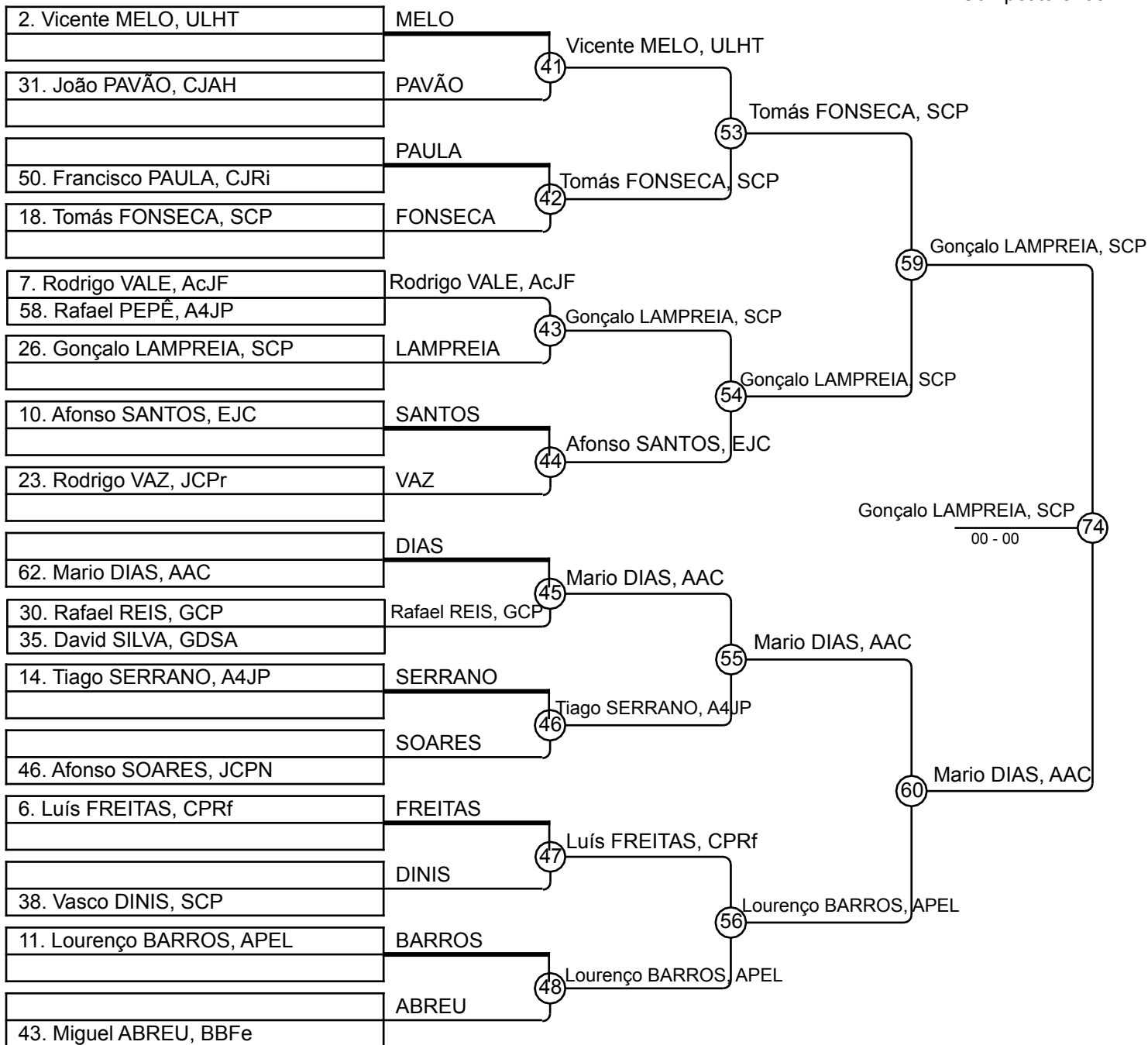

**D**



(3/3)

# CAMPEONATO AS NACIONAL DE JUNIORES

## ALBUFEIRA – 2 DE MARÇO DE 2024

### -66 Kg

Competitors: 35

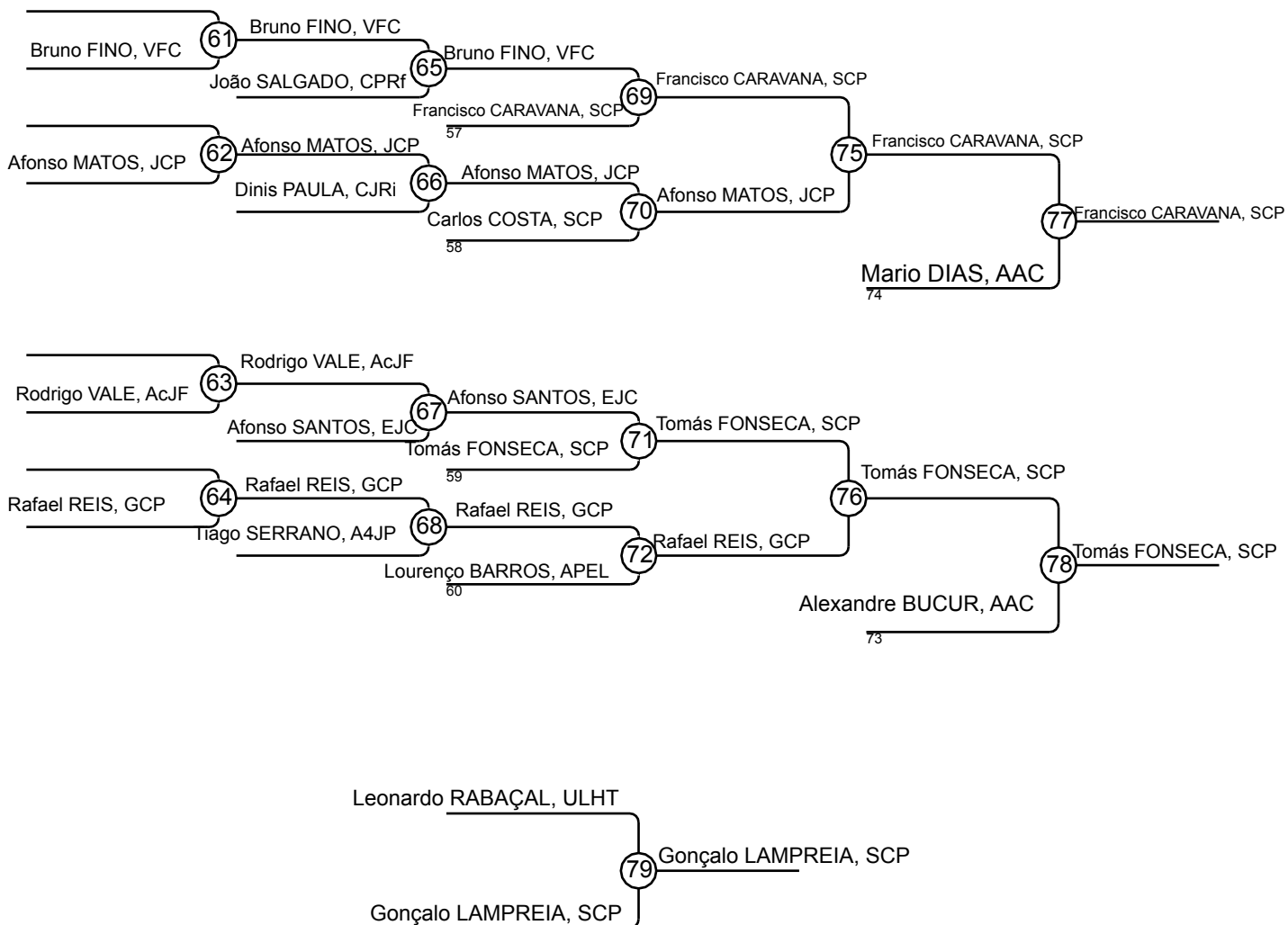

## Results

Pos	Name
1	Gonçalo LAMPREIA, SCP
2	Leonardo RABAÇAL, ULHT
3	Francisco CARAVANA, SCP
3	Tomás FONSECA, SCP
5	Mario DIAS, AAC
5	Alexandre BUCUR, AAC
7	Afonso MATOS, JCP
7	Rafael REIS, GCP



# CAMPEONATO AS NACIONAL DE JUNIORES

## ALBUFEIRA – 2 DE MARÇO DE 2024

### -73 Kg

Competitors: 32

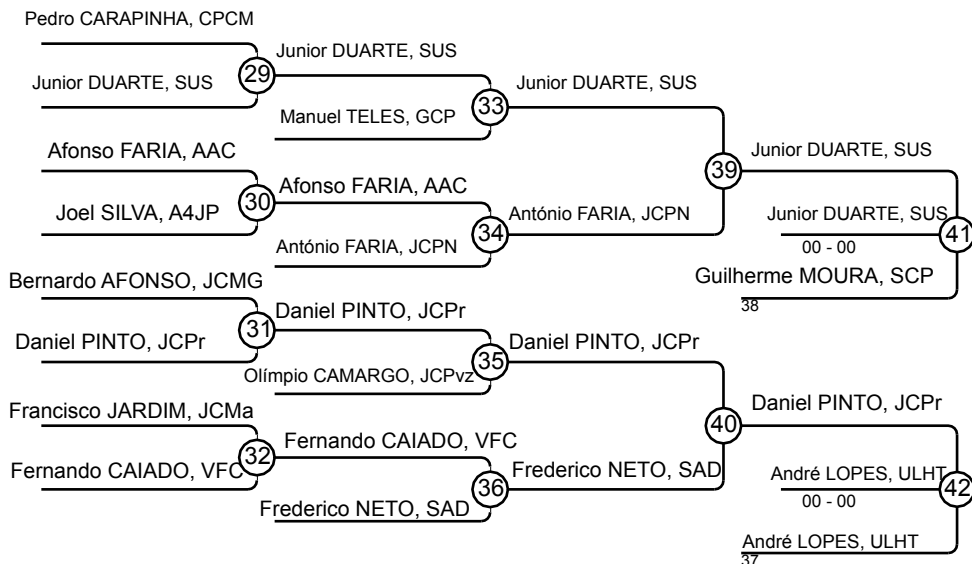
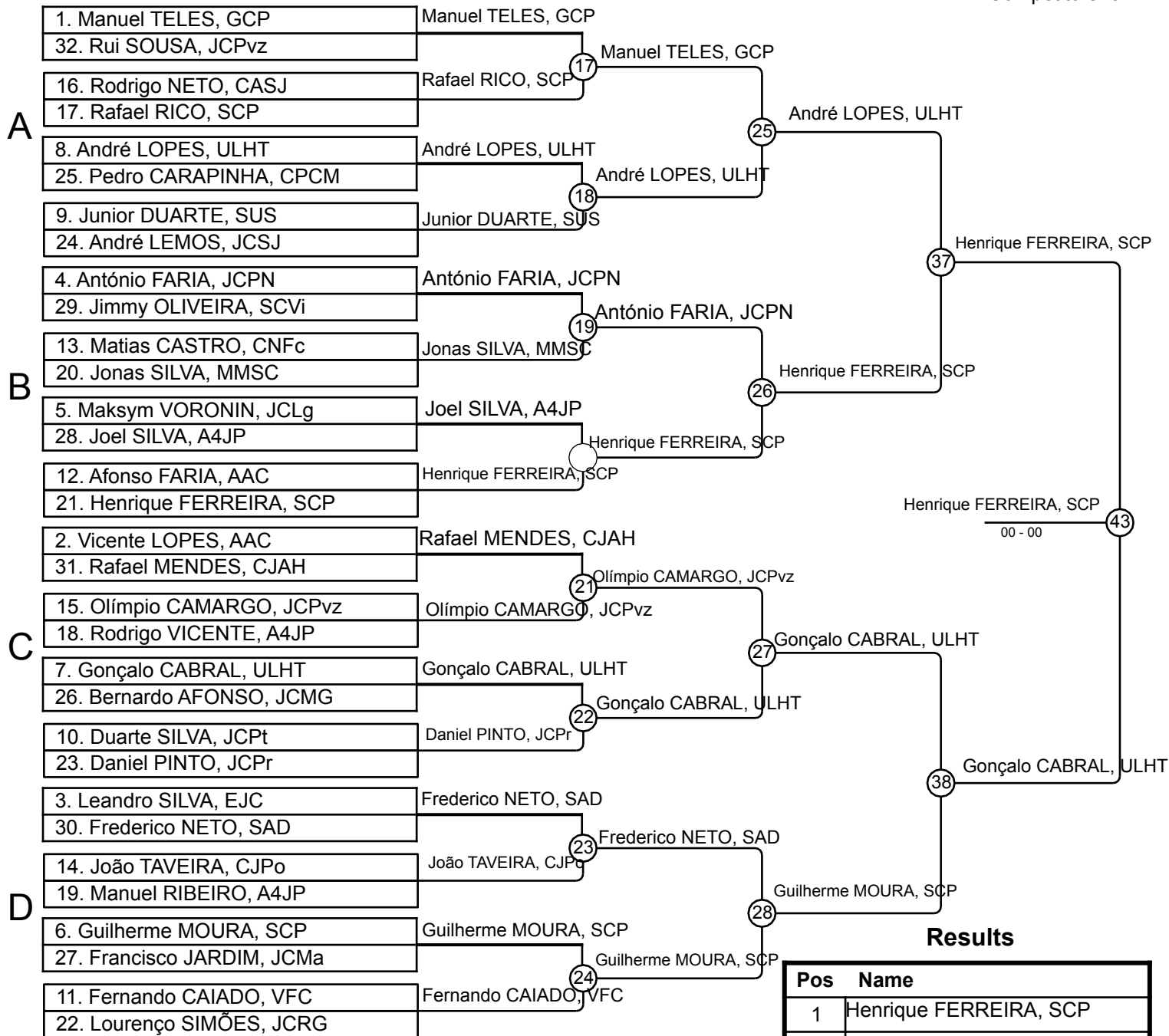

# CAMPEONATO AS NACIONAL DE JUNIORES

## ALBUFEIRA – 2 DE MARÇO DE 2024

### -81 Kg

Competitors: 23

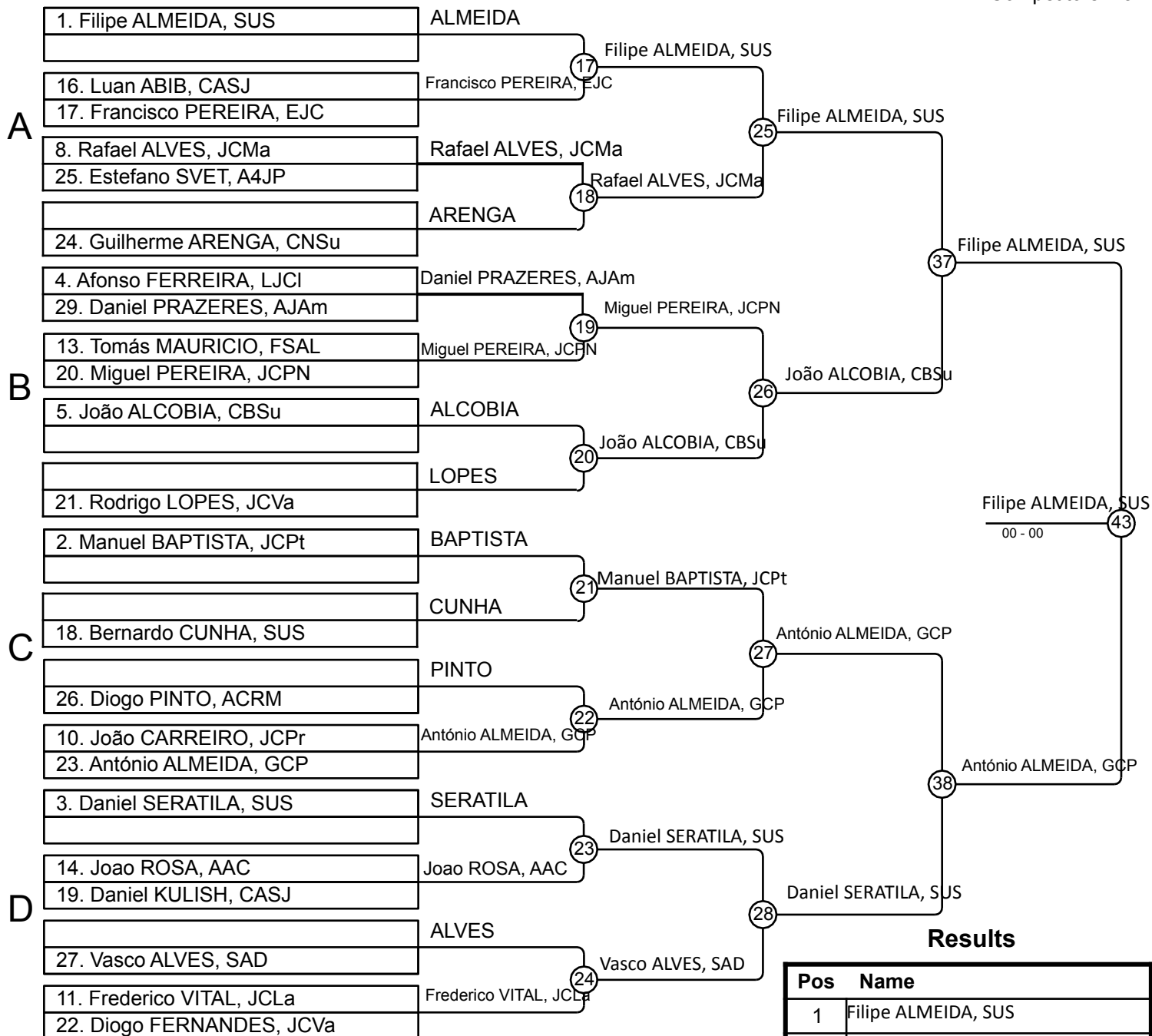

### Results

Pos	Name
1	Filipe ALMEIDA, SUS
2	António ALMEIDA, GCP
3	Francisco PEREIRA, EJC
3	Manuel BAPTISTA, JCpt
5	Daniel SERATILA, SUS
5	João ALCOBIA, CBSu
7	Miguel PEREIRA, JCPN
7	Joao ROSA, AAC

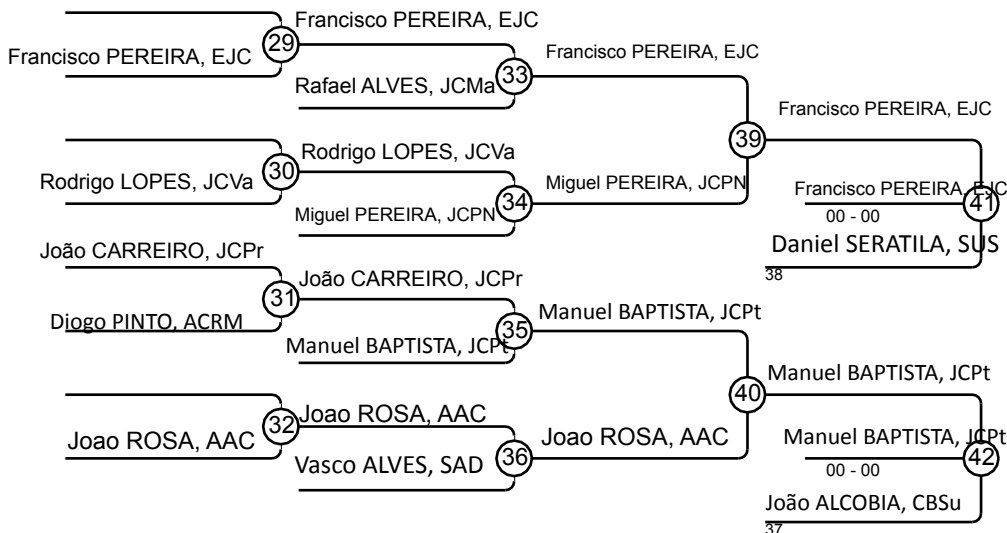

# CAMPEONATO AS NACIONAL DE JUNIORES

## ALBUFEIRA – 2 DE MARÇO DE 2024

### -90 Kg

Competitors: 12

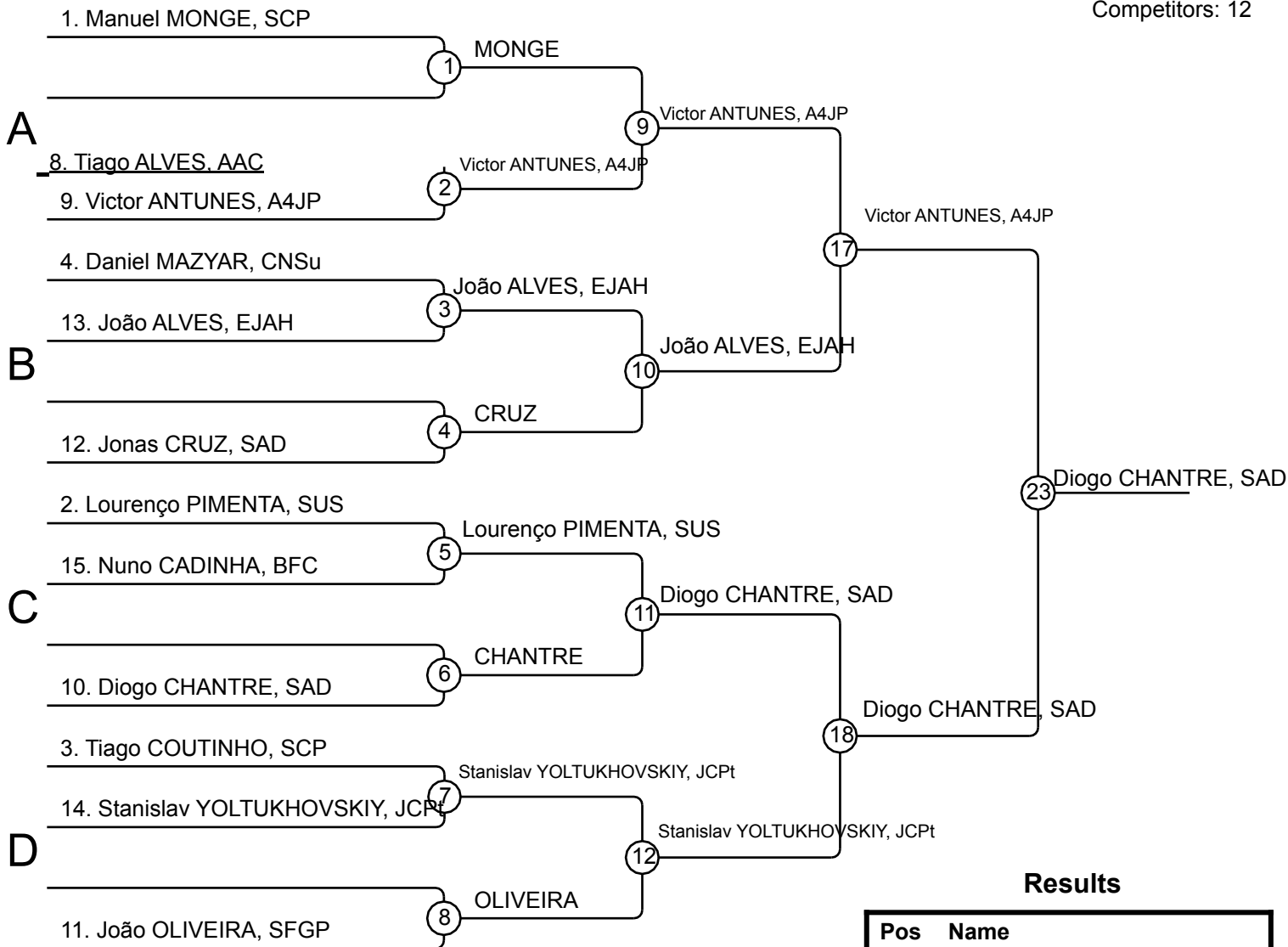

### Results

Pos	Name
1	Diogo CHANTRE, SAD
2	Victor ANTUNES, A4JP
3	Manuel MONGE, SCP
3	Lourenço PIMENTA, SUS
5	Stanislav YOLTUKHOVSKIY, JCPT
5	João ALVES, EJAH
7	Daniel MAZYAR, CNSu
7	João OLIVEIRA, SFGP

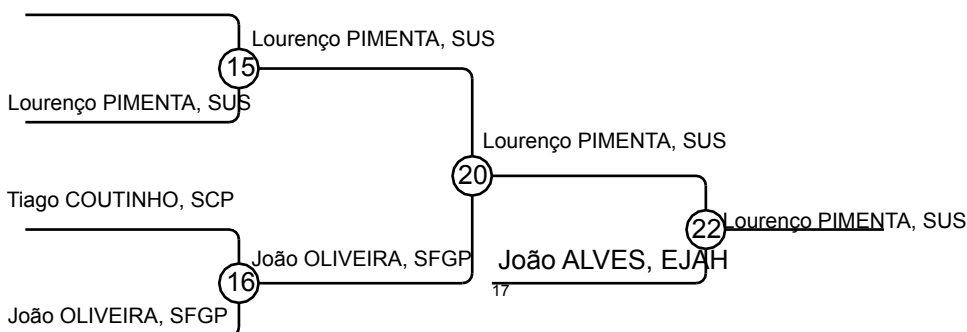
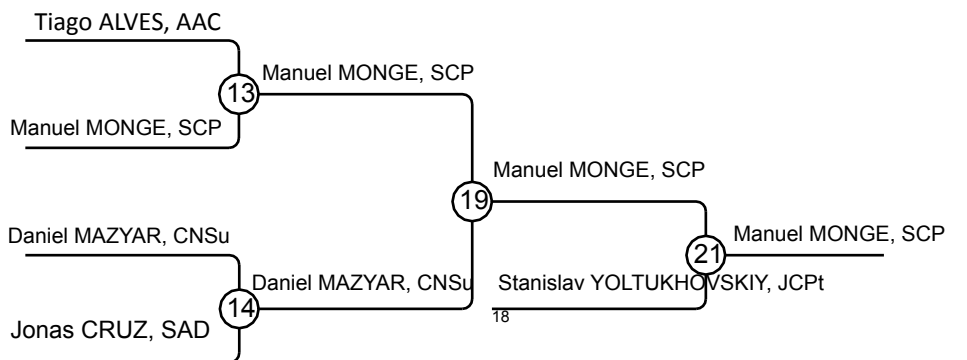

# CAMPEONATO AS NACIONAL DE JUNIORES

## ALBUFEIRA – 2 DE MARÇO DE 2024

### -100 Kg

#### Competitors

Competitors: 2

#	Name	Club	1	2	1	2	1	2	Wins	Pts	Pos
1	Romeu GUERREIRO	ULHT	D	D					0	0	
2	Max MAZYAR	CNSu	V10	V1					2	11	

#### Matches

Match	White			Blue	Result	Time
1	Romeu GUERREIRO	1	2	Max MAZYAR	MAZYAR	V10
2	Romeu GUERREIRO	1	2	Max MAZYAR	MAZYAR	V1
3	Romeu GUERREIRO	1	2	Max MAZYAR		

#### Results

Pos	Name
1	Max MAZYAR, CNSu
2	

# CAMPEONATO AS NACIONAL DE JUNIORES

## ALBUFEIRA – 2 DE MARÇO DE 2024

### +100 Kg

Competitor

Competitors: 4

#	Name	Club	1	2	3	4	Wins	Pts	Pos
1	João COITO	JCSa		V10	V10	V10	3	30	
2	Henrique SOUSA	JCLa	D		V10	V10	2	20	
3	Manuel SERRA	ULHT	D	D		V10	1	10	
4	Gabriel AZEVEDO	CPCM	D	D	D		0	0	

### Matches

Match	White	Blue	Result	Time
1	João COITO	1 2 Henrique SOUSA	COITO	V10
2	Manuel SERRA	3 4 Gabriel AZEVEDO	SERRA	V10
3	João COITO	1 3 Manuel SERRA	COITO	V10
4	Henrique SOUSA	2 4 Gabriel AZEVEDO	SOUSA	V10
5	João COITO	1 4 Gabriel AZEVEDO	COITO	V10
6	Henrique SOUSA	2 3 Manuel SERRA	SOUSA	V10

### Results

Pos	Name
1	João COITO
2	Henrique SOUSA
3	Manuel SERRA
4	

# CAMPEONATO AS NACIONAL DE JUNIORES

## ALBUFEIRA – 2 DE MARÇO DE 2024

### -48 Kg

Competitors: 10

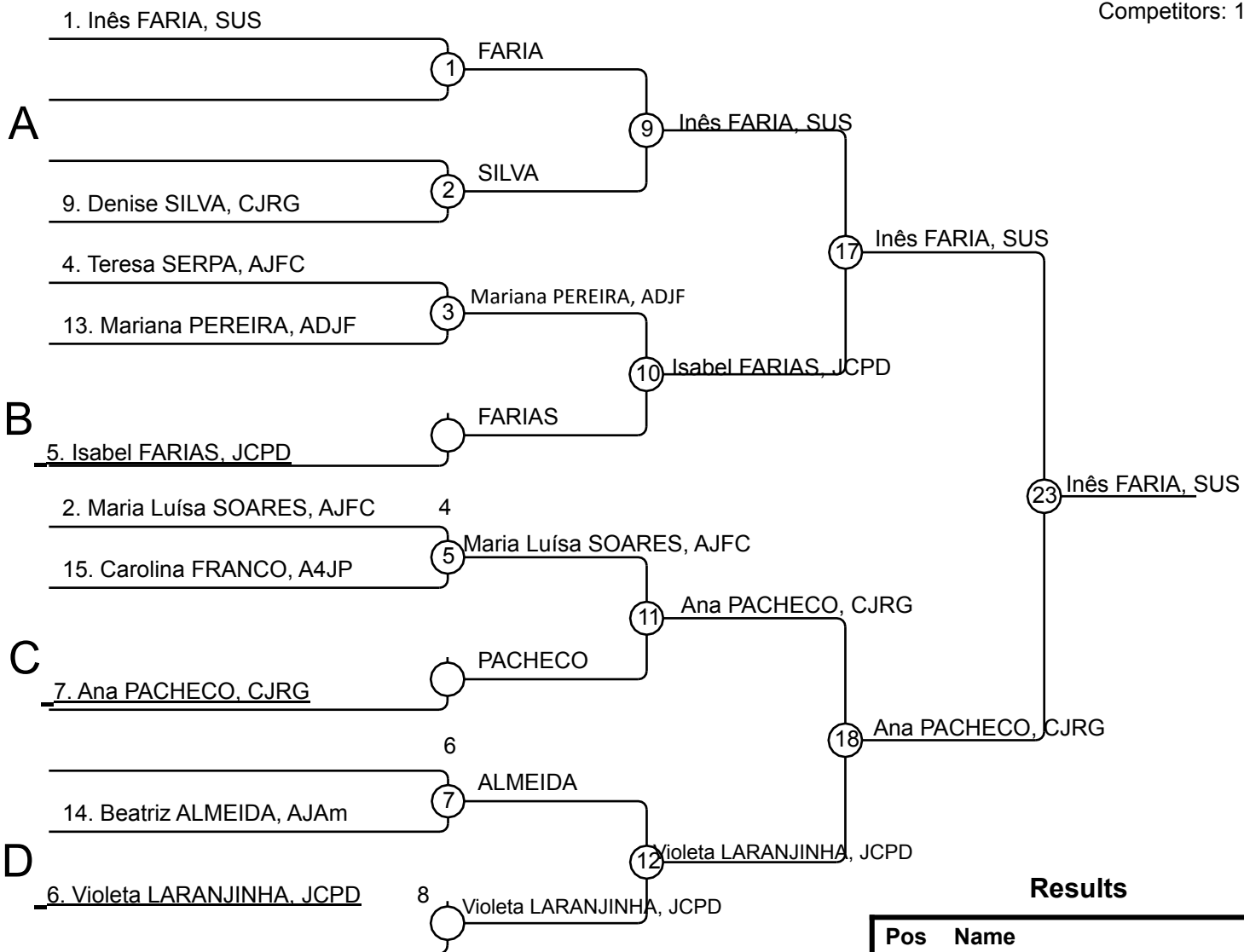

### Results

Pos	Name
1	Inês FARIA, SUS
2	Ana PACHECO, CJRG
3	Mariana PEREIRA, ADJF
3	Isabel FARIAS, JCPD
5	Violeta LARANJINHA, JCPD
5	Maria Luísa SOARES, AJFC
7	Denise SILVA, CJRG
7	Beatriz ALMEIDA, AJAm

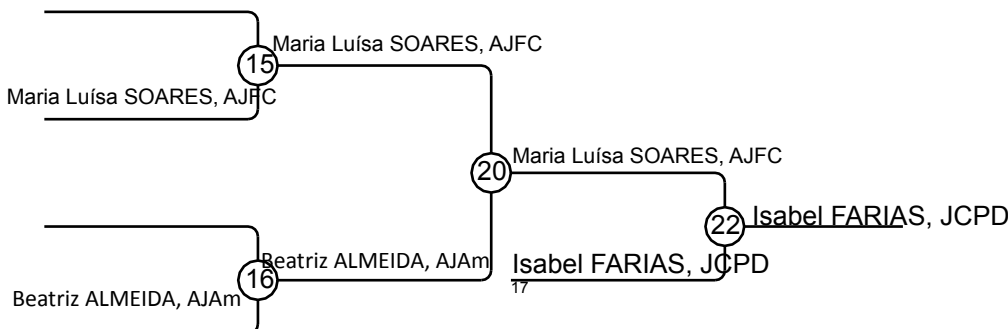
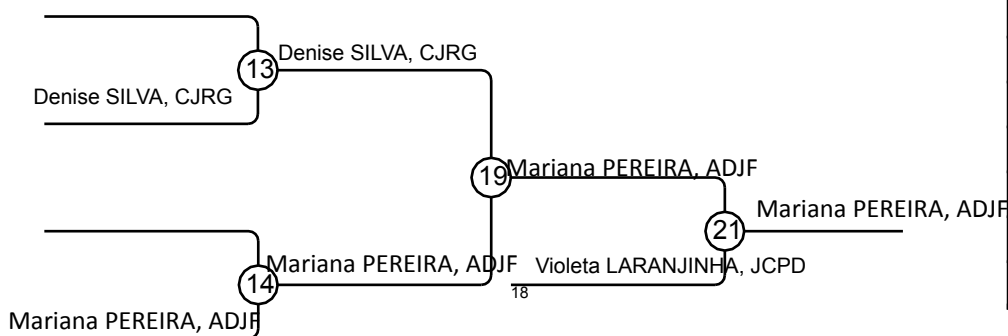





# CAMPEONATO AS NACIONAL DE JUNIORES

## ALBUFEIRA – 2 DE MARÇO DE 2024

### -57 Kg

Competitors: 15

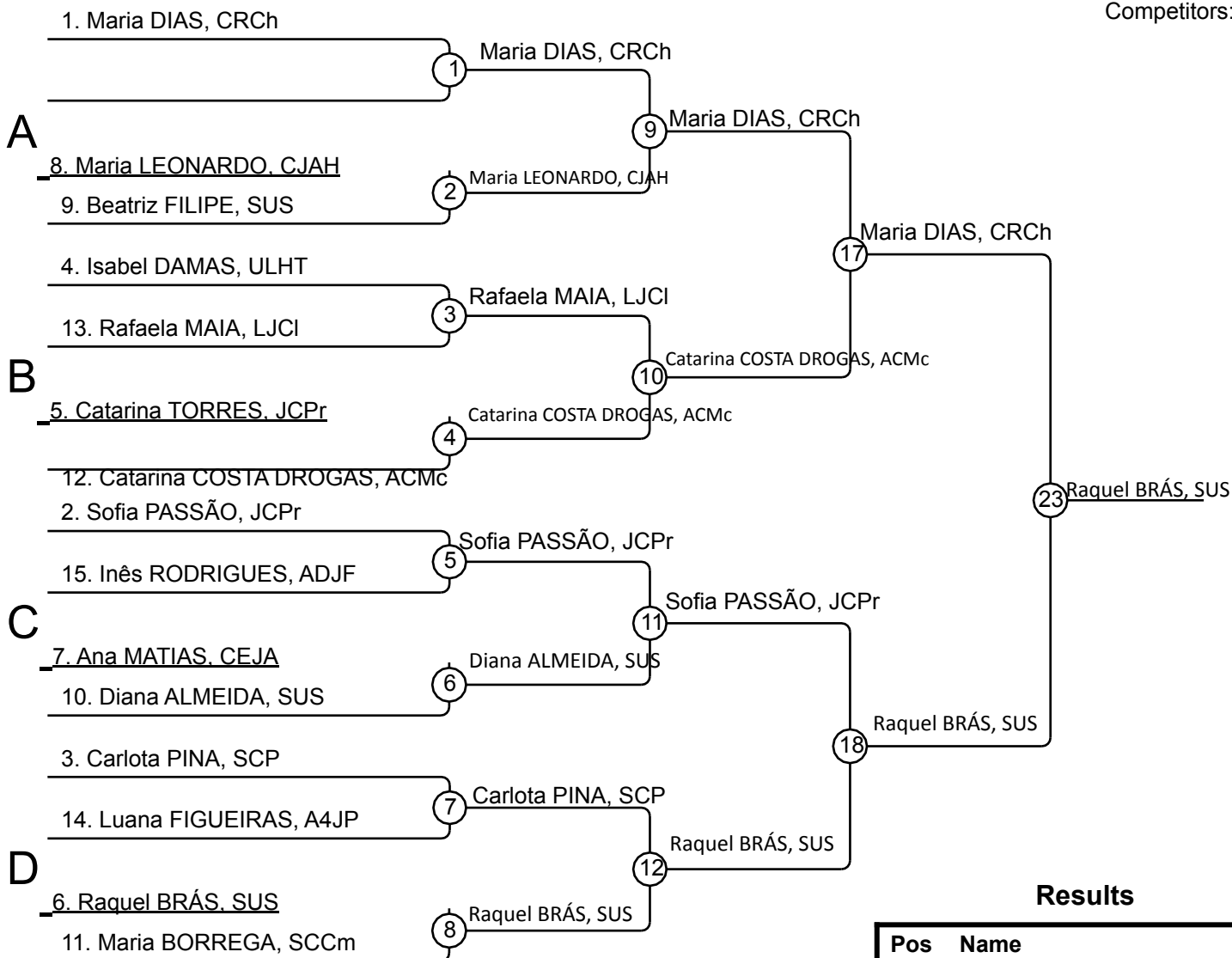

### Results

Pos	Name
1	Raquel BRÁS, SUS
2	Maria DIAS, CRCh
3	Sofia PASSÃO, JCPr
3	Carlota PINA, SCP
5	Catarina TORRES, JCPr
5	Catarina COSTA DROGAS, ACMc
7	Maria LEONARDO, CIAH
7	Diana ALMEIDA, SUS

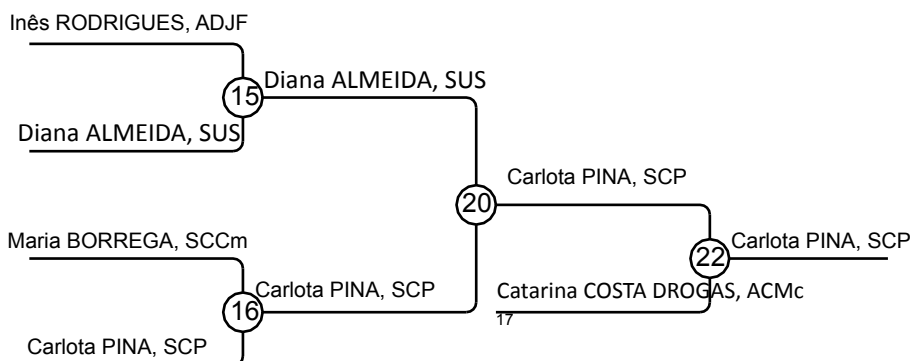
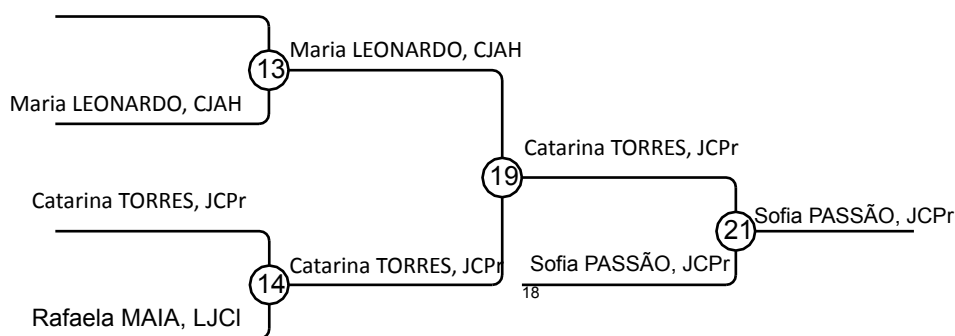

# CAMPEONATO AS NACIONAL DE JUNIORES

## ALBUFEIRA – 2 DE MARÇO DE 2024

### -63 Kg

Competitors: 15

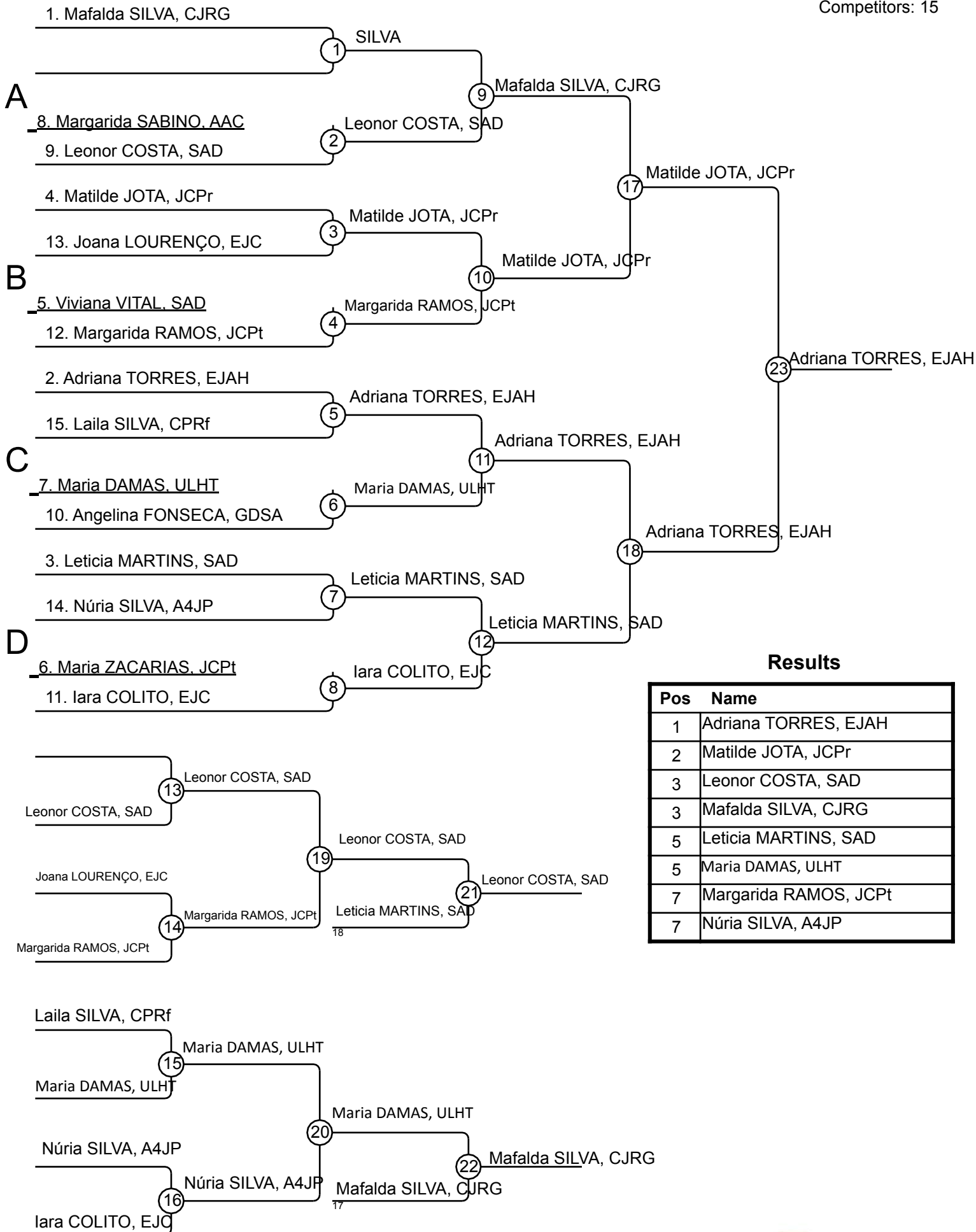

# CAMPEONATO AS NACIONAL DE JUNIORES

## ALBUFEIRA – 2 DE MARÇO DE 2024

### -70 Kg

Competitors: 12

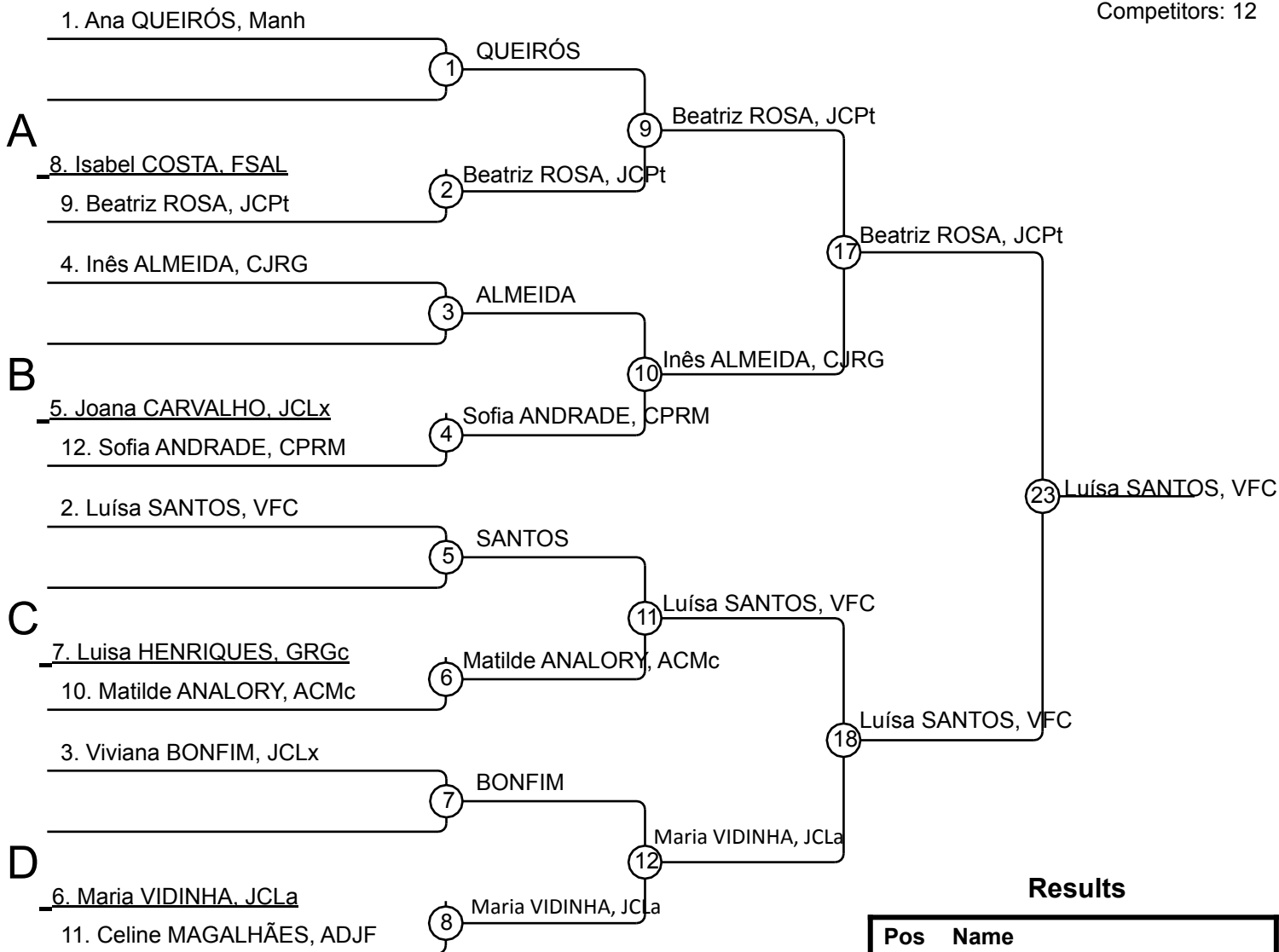

### Results

Pos	Name
1	Luísa SANTOS, VFC
2	Beatriz ROSA, JCPT
3	Isabel COSTA, FSAL
3	Matilde ANALORY, ACMc
5	Maria VIDINHA, JCLa
5	Inês ALMEIDA, CJRG
7	Sofia ANDRADE, CPRM
7	Viviana BONFIM, JCLx

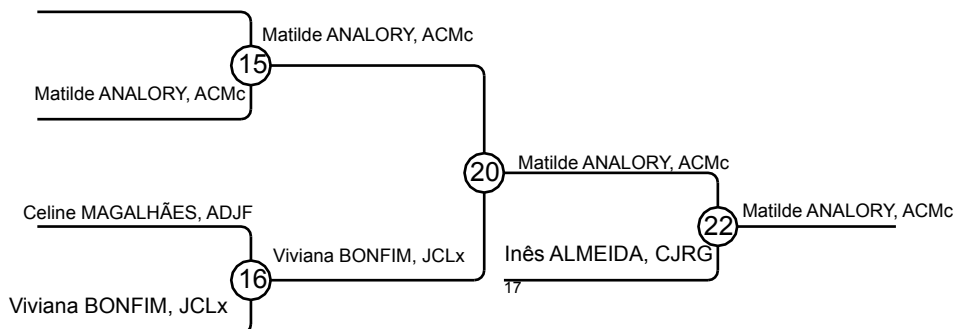
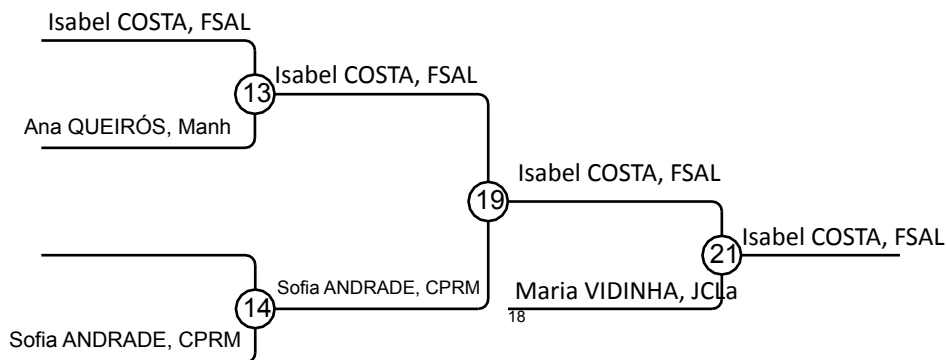

# CAMPEONATO AS NACIONAL DE JUNIORES

## ALBUFEIRA – 2 DE MARÇO DE 2024

### -78 Kg

Competitor

Competitors: 2

#	Name	Club	1	2	1	2	1	2	Wins	Pts	Pos
1	Fábia CONCEIÇÃO	SUS	V10	V10							
2	Constança MARQUES	COCS	D	D							

### Matches

Match	White	Blue	Result	Time
1	Fábia CONCEIÇÃO	Constança MARQUES	CONCEIÇÃO	V10
2	Fábia CONCEIÇÃO	Constança MARQUES	CONCEIÇÃO	V10
3	Fábia CONCEIÇÃO	Constança MARQUES		

### Results

Pos	Name
1	Fábia CONCEIÇÃO SUS

# CAMPEONATO AS NACIONAL DE JUNIORES

## ALBUFEIRA – 2 DE MARÇO DE 2024

### +78 Kg

#### Competitors

Competitors: 8

#	Name	Club	1	2	3	4	Wins	Pts	Pos
1	Constança LOPES	SUS		D	V10	V10	2	20	2°
2	Rosa MANÉ	JCAI	V10		V10	V10	3	30	1°
3	Leonor FERREIRA	CEJA	D	D		D	0	0	
4	Érica SILVA	ACRM	D	D	V10		1	10	

#### Matches A

Match	White	Blue	Result	Time
1	Constança LOPES	1 2 Rosa MANÉ	MANÉ	V10
3	Leonor FERREIRA	3 4 Érica SILVA	SILVA	V10
5	Constança LOPES	1 3 Leonor FERREIRA	LOPES	V10
7	Rosa MANÉ	2 4 Érica SILVA	MANÉ	V10
9	Constança LOPES	1 4 Érica SILVA	LOPES	V10
11	Rosa MANÉ	2 3 Leonor FERREIRA	MANÉ	V10

#### Competitors

#	Name	Club	5	6	7	8	Wins	Pts	Pos
5	Mariana NUNES	ADJF		V10	D	V10	2	10	
6	Maria COLITO	EJC	D		V10	D	1	10	
7	Ana SILVA	Manh	V10	D		V10	2	20	
8	Cristina SILVA	BVBJudo	D	V10	D		1	10	

#### Matches B

Match	White	Blue	Result	Time
2	Mariana NUNES	5 6 Maria COLITO	Mariana	V10
4	Ana SILVA	7 8 Cristina SILVA	Ana SILVA	V10
6	Mariana NUNES	5 7 Ana SILVA	Ana SILVA	V10
8	Maria COLITO	6 8 Cristina SILVA	Cristina SILVA	V10
10	Mariana NUNES	5 8 Cristina SILVA	Mariana	V10
12	Maria COLITO	6 7 Ana SILVA	Maria	V10

Rosa MANÉ, JCAI

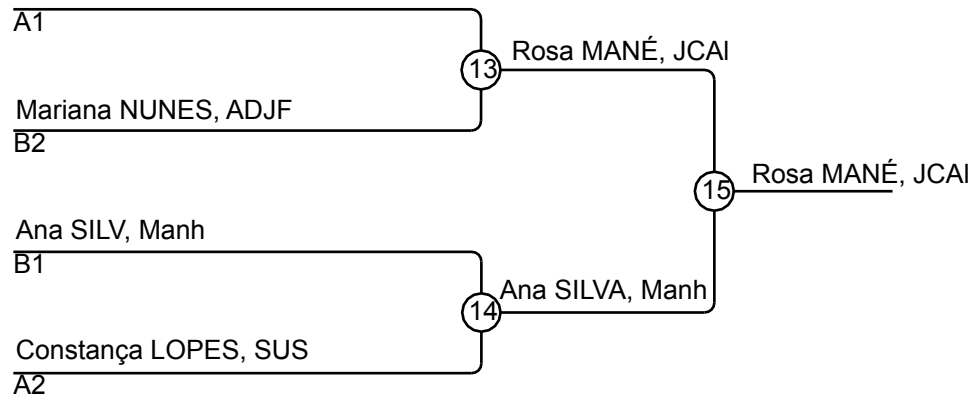

#### Results

Pos	Name
1	Rosa MANÉ, JCAI
2	Ana SILVA, Manh
3	Mariana NUNES, ADJF
3	Constança LOPES, SUS



79 CLUBES	MASCULINO								FEMININO								TOTAL
	-60 Kg	-66 Kg	-73 Kg	-81 Kg	-90 Kg	-100 Kg	+100 Kg	TOTAL	-48 Kg	-52 Kg	-57 Kg	-63 Kg	-70 Kg	-78 Kg	+78 Kg	TOTAL	
<b>Lisboa</b>	11	10	9	9	6	2	1	48	4	7	5	4	4	1	1	26	74
Lisboa (14 clubes)	11	10	9	9	6	2	1	48	4	7	5	4	4	1	1	26	74
AJAm	1			1				2	1	1						2	4
AJFC								0	2							2	2
CAAL								0		1						1	1
CBSu				1				1								0	1
CNSu	2			1	1	1		5								0	5
FSAL	1	1		1				3				1				1	4
GCP		1	1	1				3								0	3
GRGc								0				1				1	1
JCLx	3							3				2				2	5
JCP		1						1		1						1	2
MMSC				1				1								0	1
SAD	2		1	1	2			6	2			3				5	11
SCP	1	5	3	3	2			11	1	1	1					2	13
SUS			1	3	1			5	1	1	3			1	1	7	12
ULHT	1	2	2			1	1	7			1	1				2	9
<b>Norte</b>	6	6	7	4	2	0	0	25	2	1	2	2	2	0	3	12	37
Aveiro (3 clubes)	4	4	3	2	1	0	0	14	1	0	1	1	0	0	1	4	18
A4JP	3	4	3	1	1			12	1		1	1				3	15
ACRM				1				1						1		1	2
ARCB	1							1								0	1
Porto (4 clubes)	1	0	3	0	1	0	0	5	1	1	1	0	1	0	1	5	10
ADJF					1			0	1	1	1		1		1	5	5
BFC								1								0	1
CJPo			1					1								0	1
JCPv	1		2					3								0	3
Viana do Castelo (4 clubes)	0	2	1	2	0	0	0	5	0	0	0	1	1	0	1	3	8
CPRf		2						2				1				1	3
JCVa				2				2								0	2
Manh								0				1		1		2	2
SCVi			1					1								0	1
Viseu (1 clube)	1	0	0	0	0	0	0	1	0	0	0	0	0	0	0	0	1
AVAJ	1							1								0	1
<b>Centro</b>	3	6	4	3	2	0	1	19	0	3	2	4	2	1	1	13	32
Coimbra (3 clubes)	2	3	3	2	1	0	0	11	0	1	1	3	1	0	1	7	18
AAC	1	2	2	1	1			7				1				1	8
ACMC								0			1		1			2	2
EJC	1	1	1	1				4		1		2			1	4	8
Leiria (2 clubes)	0	1	1	0	0	0	0	2	0	0	0	1	0	0	0	1	3
GDSA		1						1				1				1	2
JCMG			1					1								0	1
Santarém (6 clubes)	1	2	0	1	1	0	1	6	0	2	1	0	1	1	0	5	11
CJRI		2						2		1						1	3
COCS								0					1			1	1
CPRM								0	1			1				2	2
JCSa	1						1	2								0	2
LJCI				1				1			1					1	2
SFGP					1			1								0	1
<b>Centro-Sul</b>	2	3	1	0	1	0	1	8	0	1	1	1	0	0	0	3	11
Castelo Branco (1 clube)	0	0	0	0	1	0	0	1	0	0	0	1	0	0	0	1	2
EJAH					1			1				1				1	2
Portalegre (3 clubes)	2	3	1	0	0	0	1	7	0	1	1	0	0	0	0	2	9
BBFe	1	2						3								0	3
CPCM	1	1	1				1	4								0	4
SCCm								0	1	1						2	2
<b>Sul</b>	7	6	6	5	1	0	0	25	0	1	3	3	2	0	2	11	36
Algarve (7 clubes)	2	1	3	3	1	0	0	10	0	1	0	2	1	0	2	6	16
AcF		1						1								0	1
AJAr	1							1								0	1
BVBJudo								0						1		1	1
CASJ			1	2				3	1							1	4
JCAI								0						1		1	1
JCLg			1					1								0	1
JCPt	1		1	1	1			4				2	1			3	7
Setúbal (4 clubes)	5	5	3	2	0	0	0	15	0	0	3	1	1	0	0	5	20
CRCh	2	1						3			1					1	4
JCPN		2	1	1				4								0	4
JCPv	3	1	1	1				6			2	1				3	9
VFC		1	1					2					1			1	3
<b>Reg. Aut. Açores</b>	3	2	3	1	0	0	1	10	4	2	2	1	2	0	1	12	22
Açores (7 clubes)	3	2	3	1	0	0	1	10	4	2	2	1	2	0	1	12	22
CEJA								0		1	1				1	3	3
CJAH		1	1					2		1	1					2	4
CIRG	1							1	2			1	1			4	5
JCLa	1			1			1	3					1			1	4
JCPD								0	2							2	2
JCRG	1	1	1					3								0	3
JCSJ			1					1								0	1
<b>Reg. Aut. Madeira</b>	1	2	2	1	0	0	0	6	0	1	0	0	0	0	0	1	7
Madeira (3 clubes)	1	2	2	1	0	0	0	6	0	1	0	0	0	0	0	1	7
APEL		1						1								0	1
CNFC	1	1	1					3								0	3
JCMA			1	1				2		1						1	3
<b>TOTAL</b>	33	35	32	23	12	2	4	141	10	16	15	15	12	2	8	78	219



MEDALHEIRO CASN JUNIORES 2024 - GERAL

	CLUBE	1º Class.	2º Class.	3º Class.	TOTAL
1	SUS	5		3	8
2	SCP	2		4	6
3	CNSu	2		1	3
4	SAD	1	1	2	4
5	JCAI	1			1
5	EJAH	1			1
5	VFC	1			1
5	JCSa	1			1
9	ULHT		2	2	4
10	JCPPr		2	1	3
11	CJRG		1	1	2
11	JCPt		1	1	2
13	CRCh		1		1
13	GCP		1		1
13	Manh		1		1
13	A4JP		1		1
13	JCLa		1		1
18	ADFJ			3	3
19	JCPD			1	1
19	EJC			1	1
19	CNFC			1	1
19	CJRi			1	1
19	FSAL			1	1
19	ACMC			1	1





**MEDALHEIRO CASN JUNIORES 2024 - FEMININO**

	<b>CLUBE</b>	<b>1º Class.</b>	<b>2º Class.</b>	<b>3º Class.</b>	<b>TOTAL</b>
1	SUS	4		1	5
2	JCAI	1			1
2	EJAH	1			1
2	VFC	1			1
5	JCPr		1	1	2
5	SAD		1	1	2
5	CJRG		1	1	2
8	Manh		1		1
8	JCpt		1		1
8	CRCh		1		1
11	ADJF			3	3
12	FSal			1	1
12	ACMc			1	1
12	CJRi			1	1
12	JCPD			1	1
12	SCP			1	1

**MEDALHEIRO CASN JUNIORES 2024 - MASCULINO**

	<b>CLUBE</b>	<b>1º Class.</b>	<b>2º Class.</b>	<b>3º Class.</b>	<b>TOTAL</b>
1	SCP	2		3	5
2	CNSu	2		1	3
3	SUS	1		2	3
4	SAD	1		1	2
5	JCSa	1			1
6	ULHT		2	2	4
7	JCPr		1		1
7	GCP		1		1
7	A4JP		1		1
7	JCLa		1		1
11	JCpt			1	1
11	EJC			1	1
11	CNFC			1	1