



**CIRCULAR Nº 057/23**

**ASSUNTO:** Campeonato Nacional de Júniores2023 - RESULTADOS

Odivelas, 15 de março de 2023

Exmos. Senhores,

Vimos por este meio proceder à divulgação dos resultados do Campeonato Nacional de Júniores 2023.

<b>PROVA</b>	<b>Campeonato Nacional de Júniores2023</b>
<b>DATA/LOCAL</b>	Sábado, 11 de março de 2023, Pavilhão Multidesportos Dr. Mário Mexia, Coimbra
<b>ESCALÃO</b>	Júniores Masculinos e Femininos
<b>Nº ATLETAS</b>	200 Atletas Masculinos +80Atletas Femininos =280 Atletas (73 Clubes)

**RESULTADOS FINAIS**

**MASCULINOS**

<b>-60KG (61atletas)</b>				<b>-66KG (45 atletas)</b>			
1º	Gonçalo LAMPREIA	137419	SUS	1º	Miguel GAGO	120693	AAC
2º	Carlos COSTA	41908	SCP	2º	Bernardo FERNANDES	115427	ACMC
3º	João MARTINS	135961	ACMC	3º	Pedro HORTA	123894	ULHT
3º	Joaquim ROVIRA	135905	AAC	3º	Henrique FERREIRA	137547	SCP
<b>-73KG (35atletas)</b>				<b>-81KG (30atletas)</b>			
1º	Otari KVANTIDZE	157088	SCP	1º	Filipe ALMEIDA	138542	SUS
2º	Tomás GOMES	137885	SUS	2º	Rodrigo PIRES	136581	SLB
3º	António FARIA	119358	JCPN	3º	Daniel SERATILA	127719	SUS
3º	Gonçalo CABRAL	137202	ULHT	3º	Manuel BAPTISTA	129005	JCPt
<b>-90KG (20atletas)</b>				<b>-100KG (6 atletas)</b>			
1º	Pedro LIMA	128943	SAD	1º	Guilherme SILVA	117964	GRGc
2º	Manuel MONGE	145978	SCP	2º	Max MZYAR	137880	CNSu
3º	Francisco PEREIRA	142342	EJC	3º	Leonardo CORDEIRO	145307	JCJc
3º	Diogo LUIS	173166	SCP	3º	Romeu GUERREIRO	146476	CASJ



Federação Portuguesa  
de  
**Judo**

## mais do que um DESPORTO... um DESPERTAR!

INSTITUIÇÃO DE UTILIDADE PÚBLICA DESPORTIVA  
CONT N° 501 515 674  
MEMBRO DA UNIÃO EUROPEIA DE JUDO  
E DA FEDERAÇÃO INTERNACIONAL DE JUDO  
FUNDADA EM 1959



SEGUINDO A SUA POLÍTICA DE SUSTENTABILIDADE  
A FEDERAÇÃO PORTUGUESA DE JUDO  
PASSA DA ACREDITAÇÃO IMPRESSA PARA UMA VERSÃO ONLINE  
CONTANDO COM O APOIO DE TODA A FAMÍLIA DO JUDO

### +100KG (3atletas)

1º José CUNHA	154277	JCMo
2º Bruno TAVARES	144130	SLB

### FEMININOS

#### -48KG (8 atletas)

1º Inês FARIA	127721	SUS
2º Iara HENRIQUES	151280	A4JP
3º Constança ALVES	127689	SCBM
3º Matilde GONÇALVES	130780	EJAH

#### -57KG (17atletas)

1º Maria SILVEIRA	149880	SAD
2º Maria DIAS	153054	CRCh
3º Beatriz DUARTE	138223	JCPr
3º Sofia PASSÃO	130435	JCPr

#### -70KG (14 atletas)

1º Taís PINA	135954	SAD
2º Ana QUEIRÓS	140871	Manh
3º Joana MORGADO	131627	JCVC
3º Luísa SANTOS	175553	VFC

#### +78KG (5atletas)

1º Rosa MANÉ	162835	JCAI
2º Maria COLITO	157790	EJC
3º Ana SILVA	151941	Manh

#### -52KG (18 atletas)

1º Mariana MÁXIMO	139843	SCP
2º Iracema MANARTE	129642	ADJF
3º Mariana PEREIRA	157924	ADJF
3º Catarina SILVA	131533	AJAm

#### -63KG (15 atletas)

1º Mafalda SILVA	134353	CJRG
2º Adriana TORRES	122248	EJAH
3º Joana MORGADO	117202	JCVa
3º Letícia MARTINS	135950	SAD

#### -78KG (3 atletas)

1º Patrícia DIAS	141338	JCPr
2º Mónica MENDONÇA	164324	ADJF

Com os nossos melhores cumprimentos e cordiais,

Saudações Desportivas  
O Vice-Presidente da FPJ

Joaquim Sérgio Pina



(1/3)  
**CAMPEONATO AS NACIONAL JUNIORES**  
**COIMBRA – 11 DE MARÇO DE 2023**  
**-60 Kg**

Competitors: 61

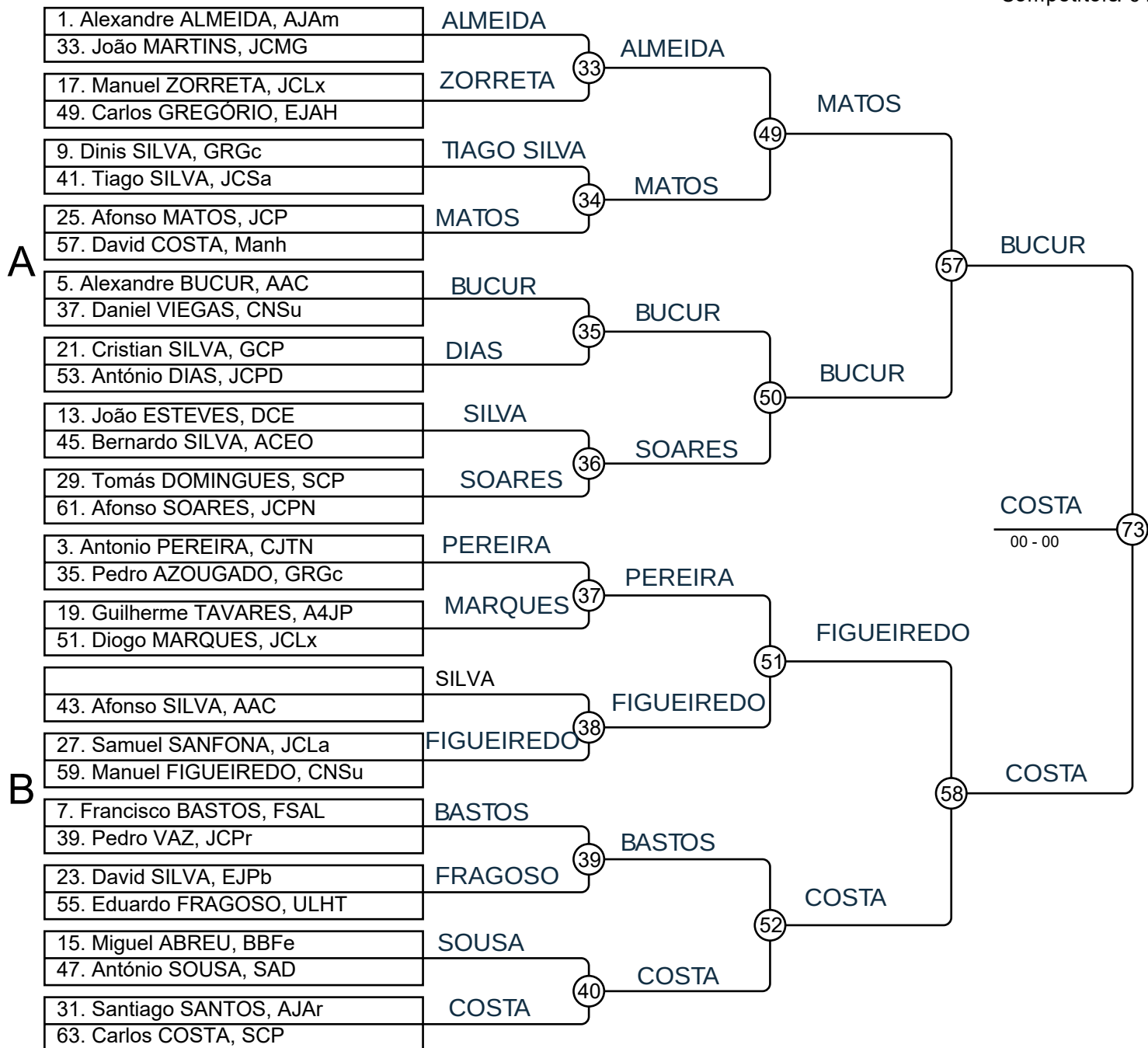

(2/3)

# CAMPEONATO AS NACIONAL JUNIORES

## COIMBRA – 11 DE MARÇO DE 2023

### -60 Kg

Competitors: 61

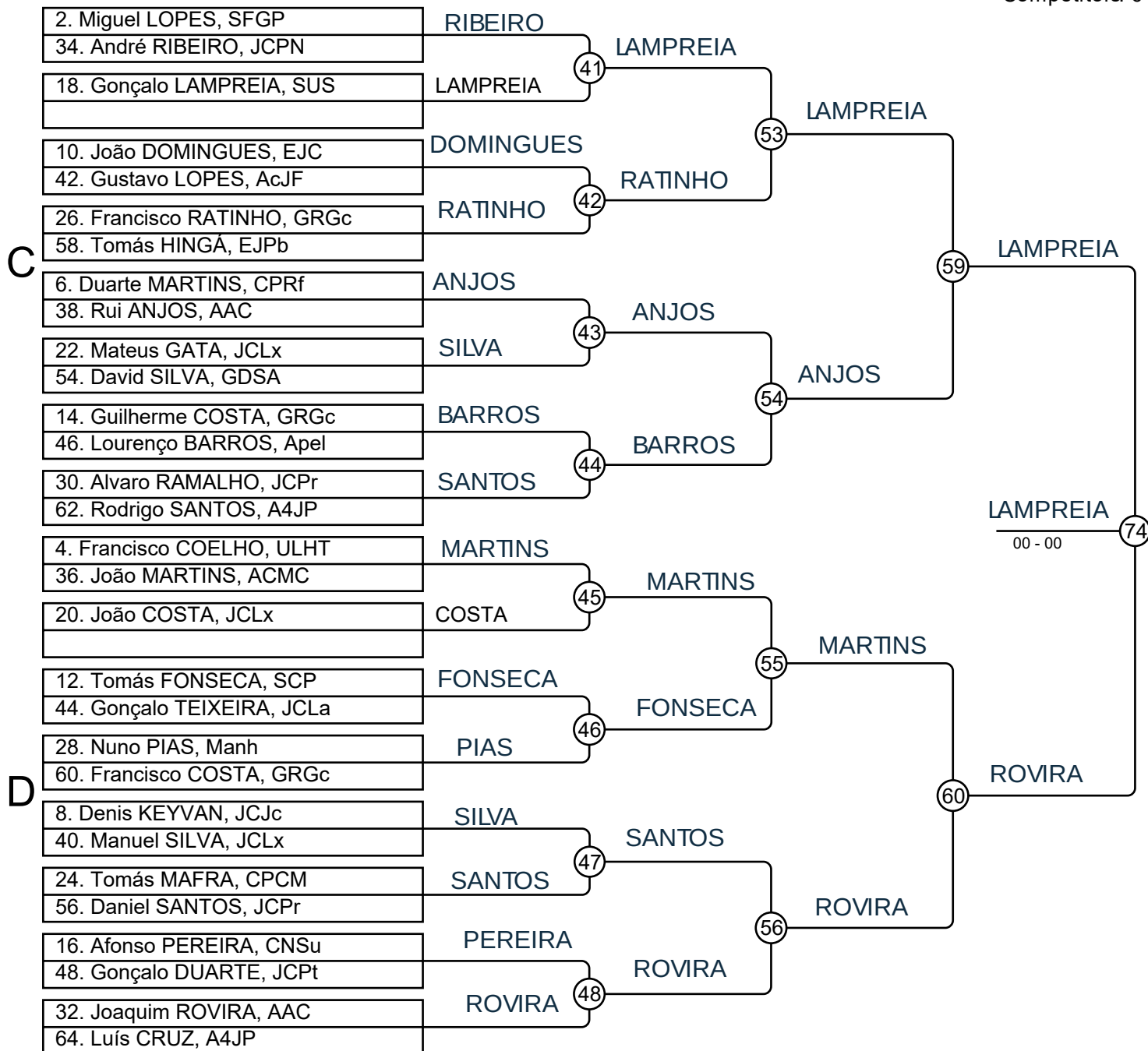

**D**

(3/3)

# CAMPEONATO AS NACIONAL JUNIORES

## COIMBRA – 11 DE MARÇO DE 2023

### -60 Kg

Competitors: 61

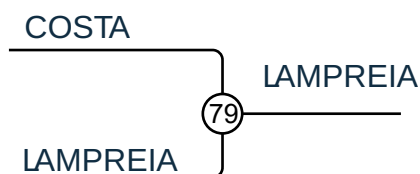
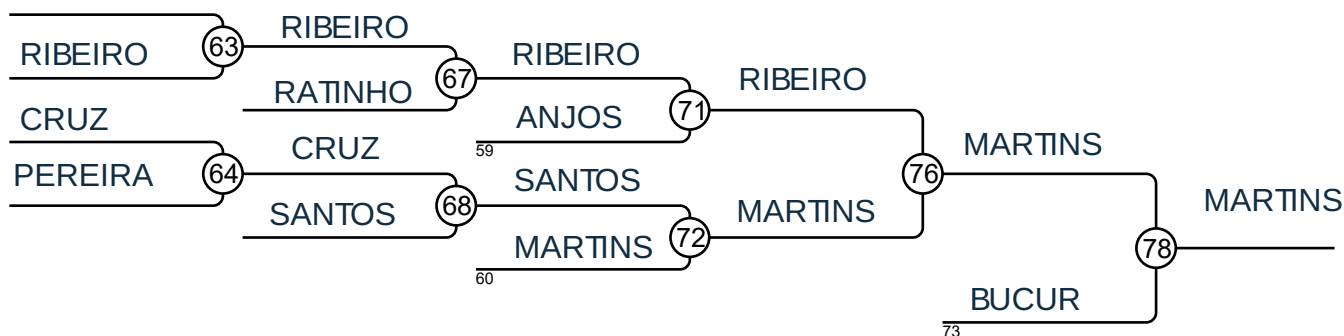
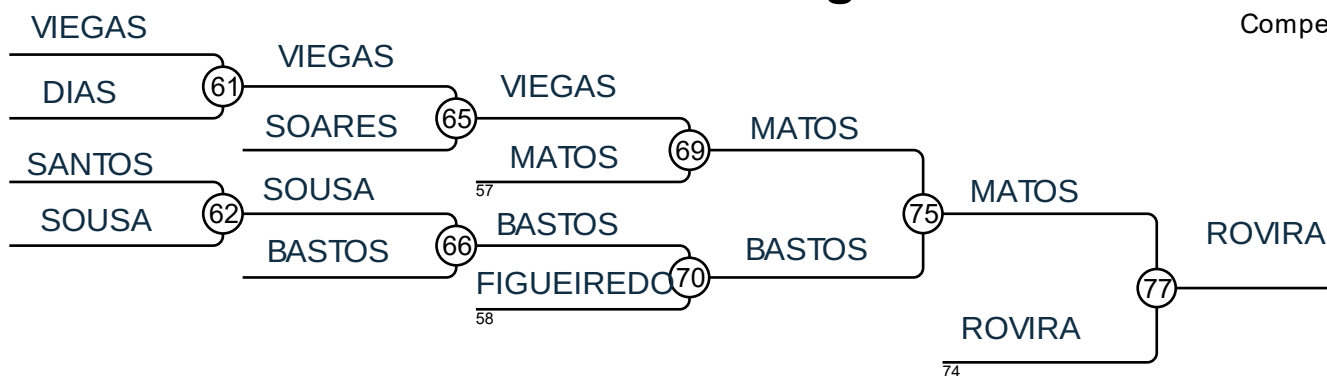

## Results

Pos	Name
1	Gonçalo LAMPREIA (SUS)
2	Calos COSTA (SCP)
3	Joaquim ROVIRA (AAC)
3	João MARTINS (ACMC)
5	
5	
7	 CADET EUROPEAN JUDO CHAMPIONSHIPS 22 - 25 JUNE 2023
7	 WORLD JUDO CHAMPIONSHIPS JUNIORS 4-8 OCTOBER 2023

(1/3)

# CAMPEONATO AS NACIONAL JUNIORES

## COIMBRA – 11 DE MARÇO DE 2023

### -66 Kg

Competitors: 45

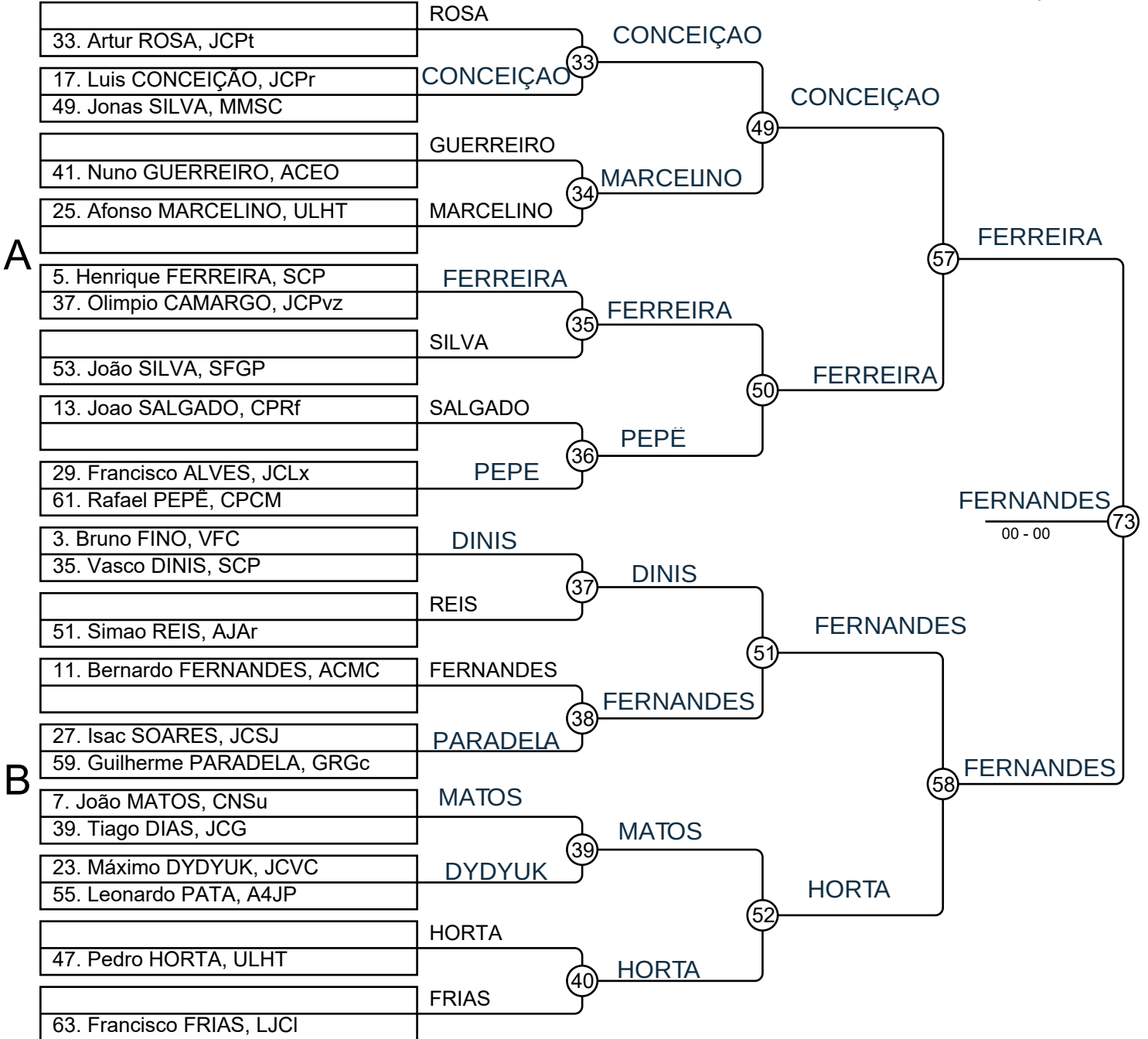

(2/3)

# CAMPEONATO AS NACIONAL JUNIORES

## COIMBRA – 11 DE MARÇO DE 2023

### -66 Kg

Competitors: 45

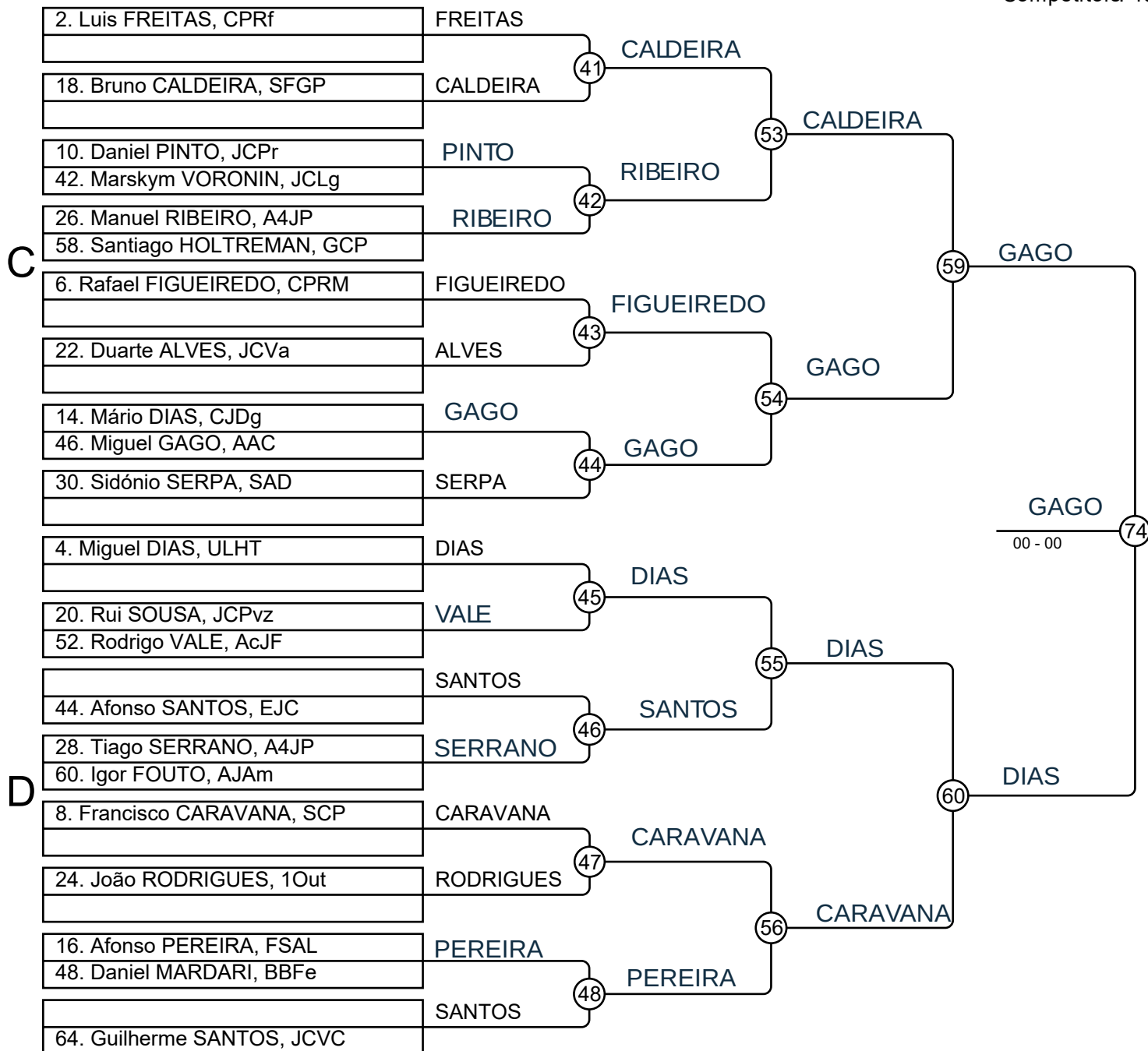

(3/3)

# CAMPEONATO AS NACIONAL JUNIORES

## COIMBRA – 11 DE MARÇO DE 2023

### -66 Kg

Competitors: 45

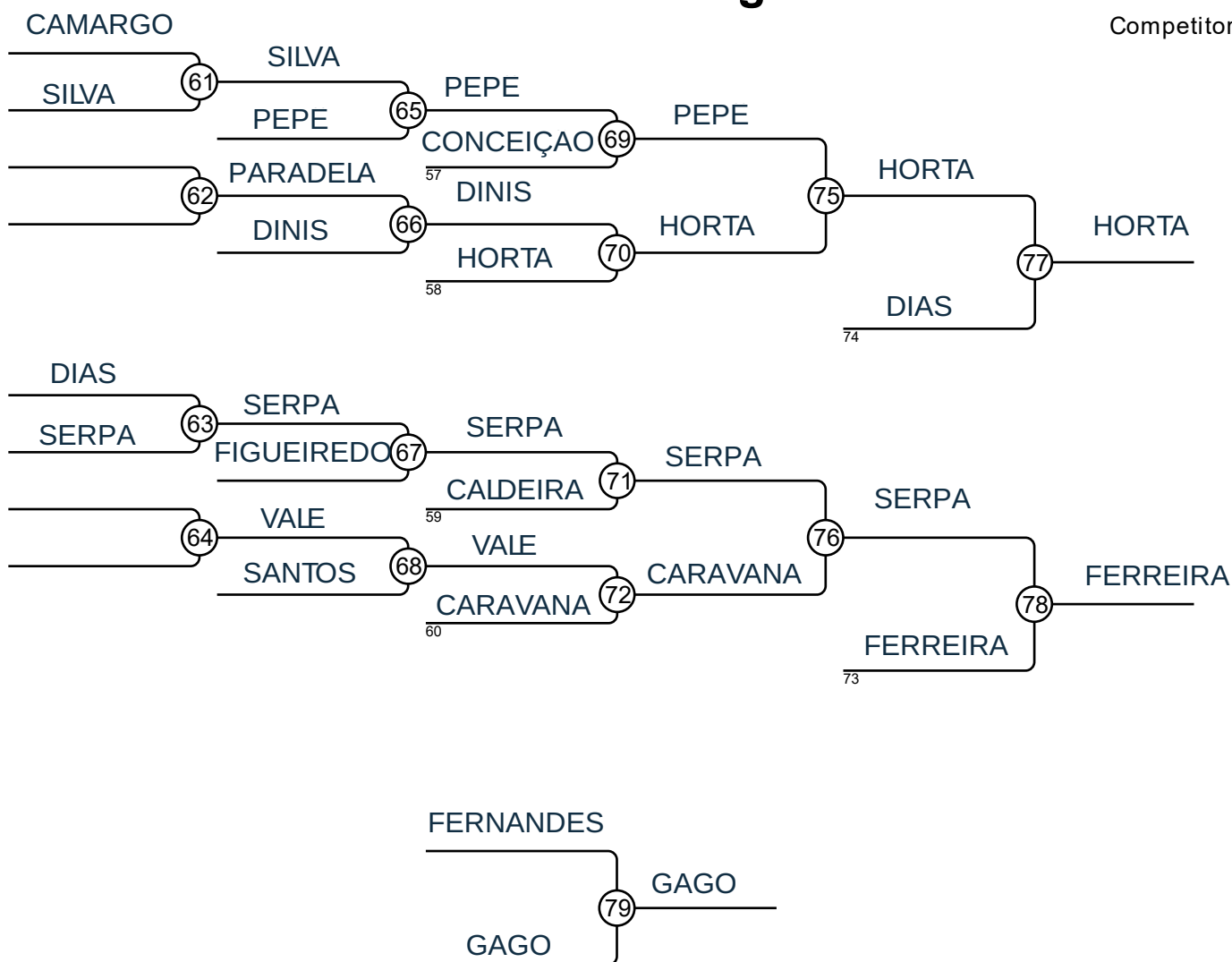

## Results

Pos	Name
1	Miguel GAGO (AAC)
2	Benado FERNANDES (ACMC)
3	Pedo HORTA (ULHT)
3	Henrique FERREIRA (SCP)
5	
5	
7	 CABOT EUROPEAN JUDO CHAMPIONSHIPS 22 - 25 JUNE 2023
7	 WORLD JUDO CHAMPIONSHIPS JUNIORS 4 - 8 OCTOBER 2023



(1/3)  
**CAMPEONATO AS NACIONAL JUNIORES**  
**COIMBRA – 11 DE MARÇO DE 2023**  
**-73 Kg**

Competitors: 35

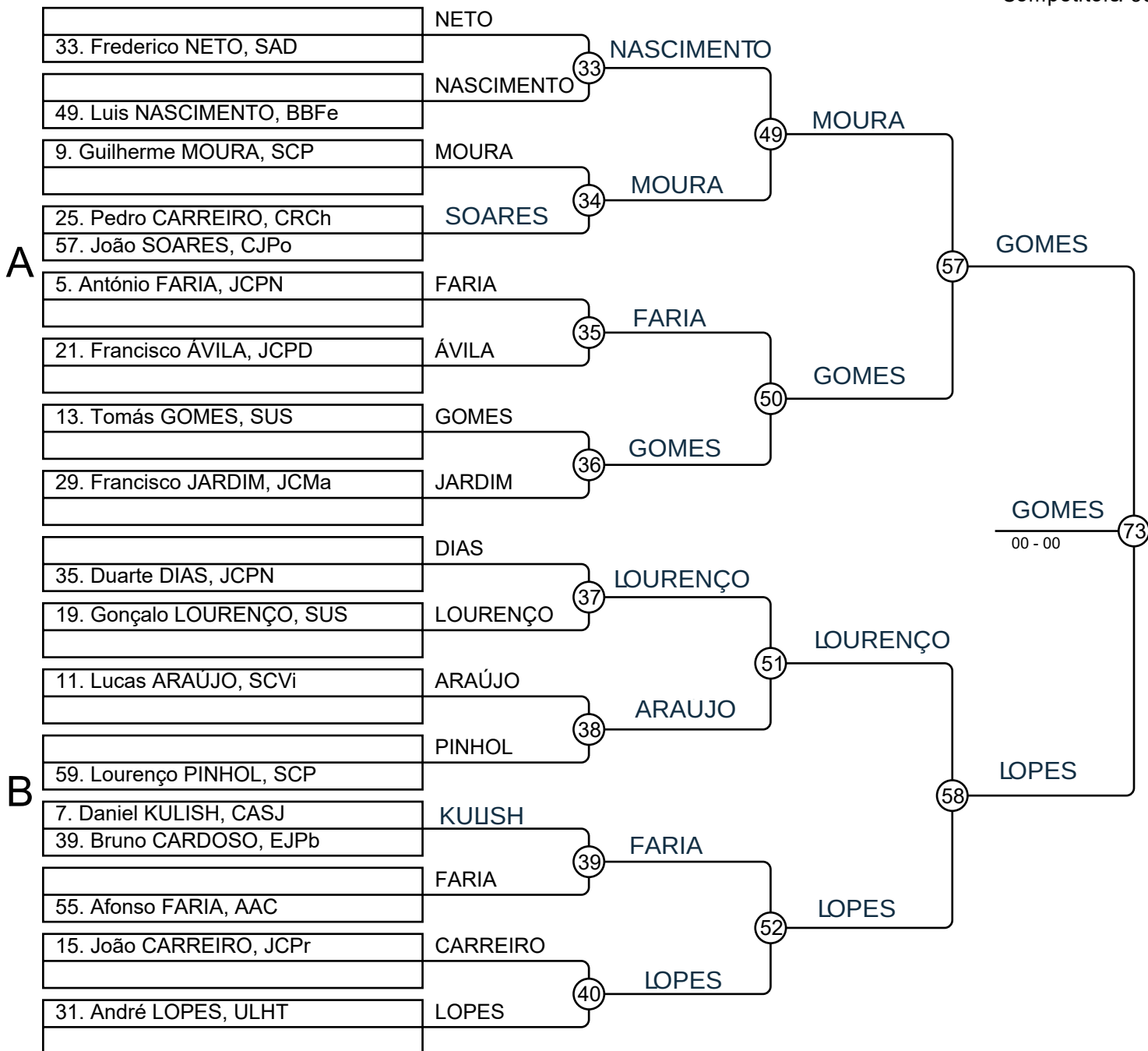

(2/3)

# CAMPEONATO AS NACIONAL JUNIORES

## COIMBRA – 11 DE MARÇO DE 2023

### -73 Kg

Competitors: 35

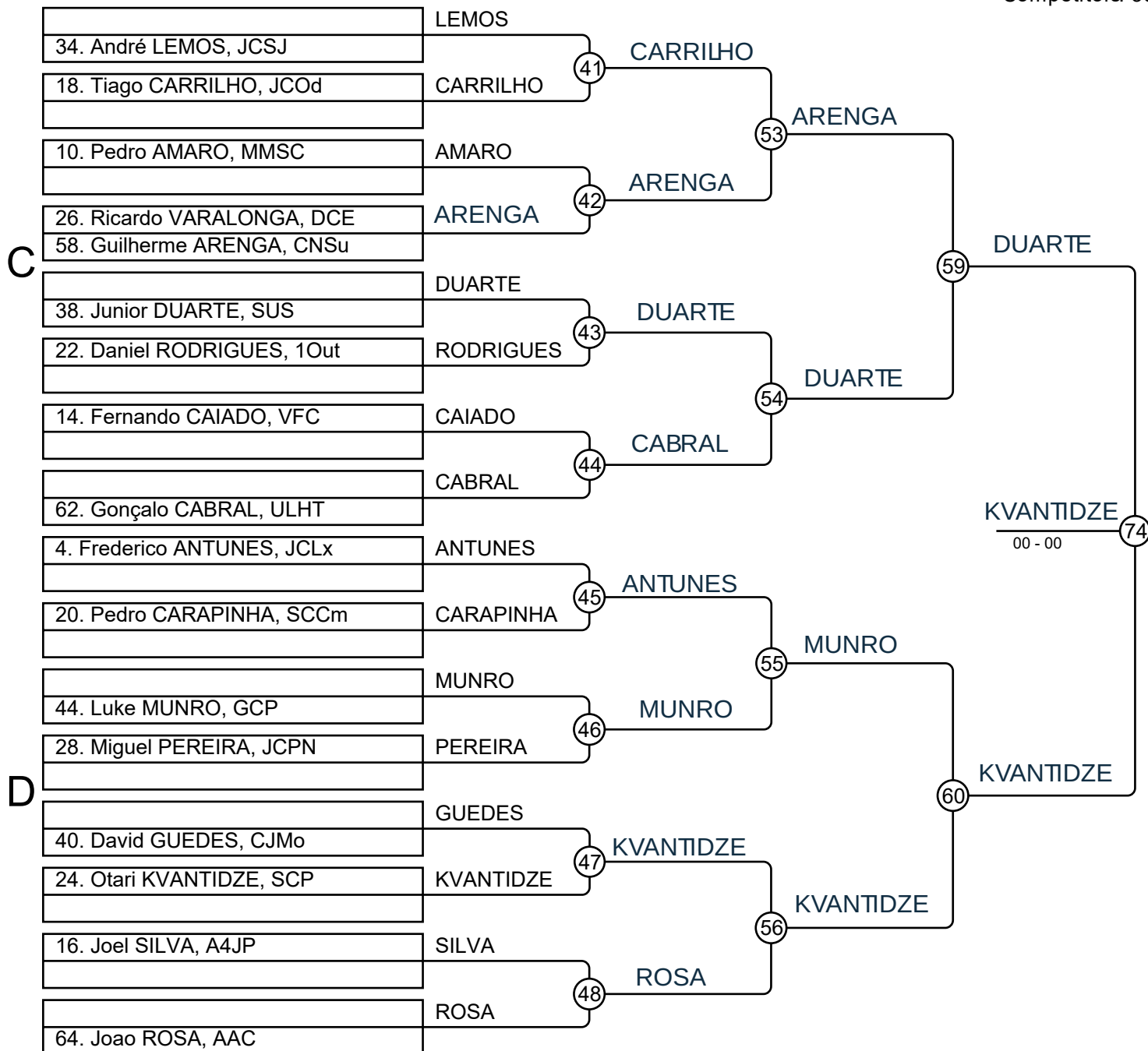

(3/3)

# CAMPEONATO AS NACIONAL JUNIORES

## COIMBRA – 11 DE MARÇO DE 2023

### -73 Kg

Competitors: 35

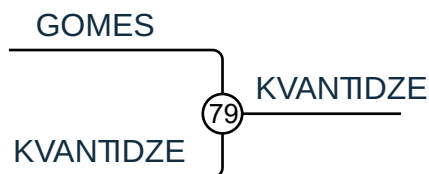
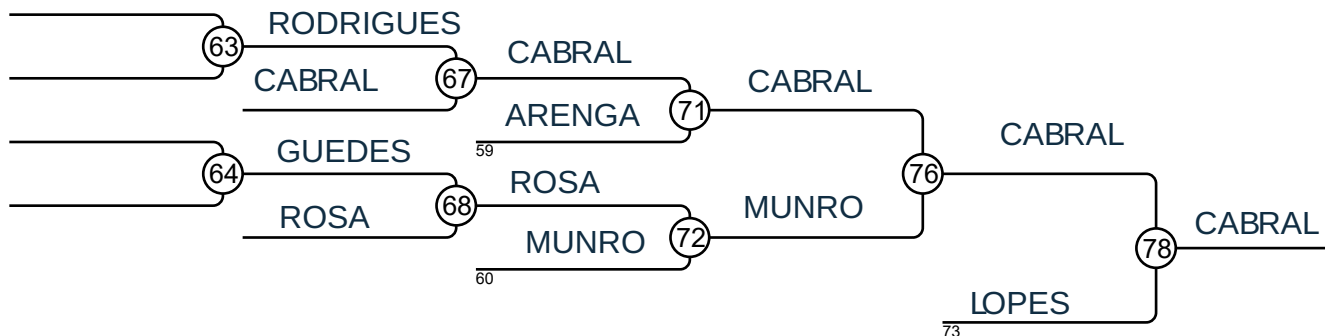
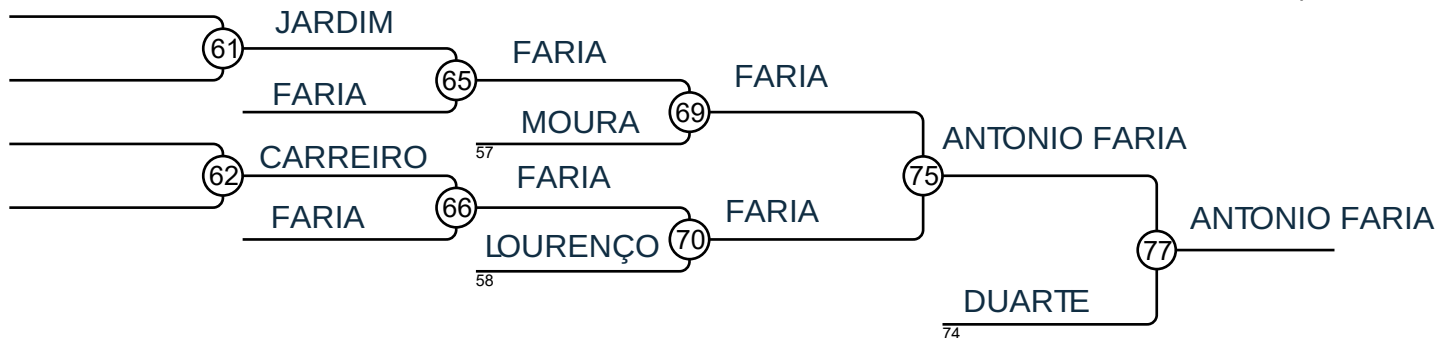

## Results

Pos	Name
1	Otar KVANTIDZE (SCP)
2	Tomás GOMES (SUS)
3	António FARIA (JCPN)
3	Gonçalo CABRAL (ULHT)
5	
5	
7	 CASPIAN EUROPEAN JUDO CHAMPIONSHIPS JUNIORS 22 - 25 JUNE 2023
7	 WORLD JUDO CHAMPIONSHIPS JUNIORS 4-8 OCTOBER 2023

# CAMPEONATO AS NACIONAL JUNIORES

## COIMBRA – 11 DE MARÇO DE 2023

### -81 Kg

Competitors: 30

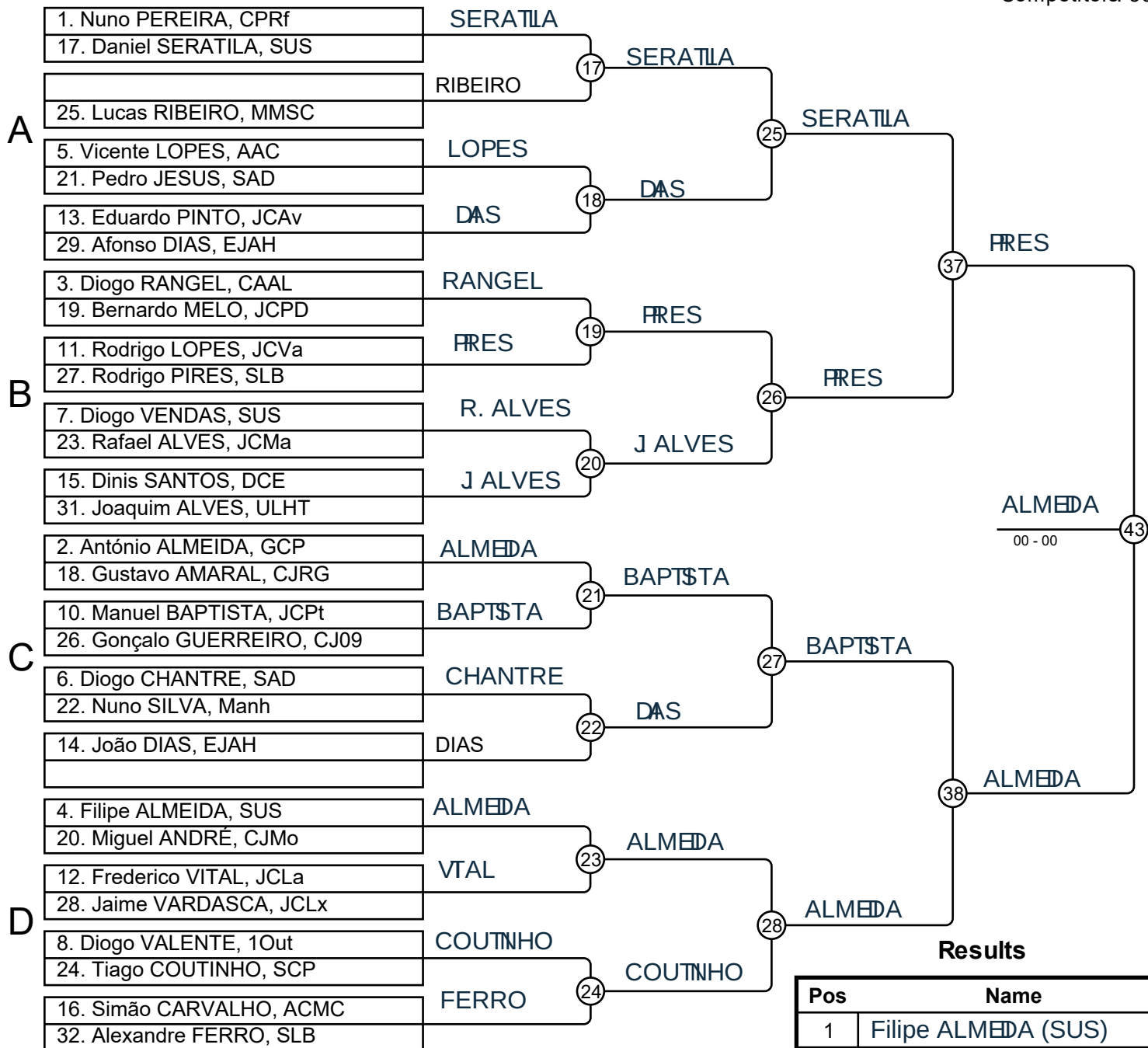

### Results

Pos	Name
1	Filipe ALMEIDA (SUS)
2	Rodrigo FRES (SLB)
3	Manuel BAPTISTA (JCPt)
3	Daniel SERATILA (SUS)
5	
5	
7	
7	

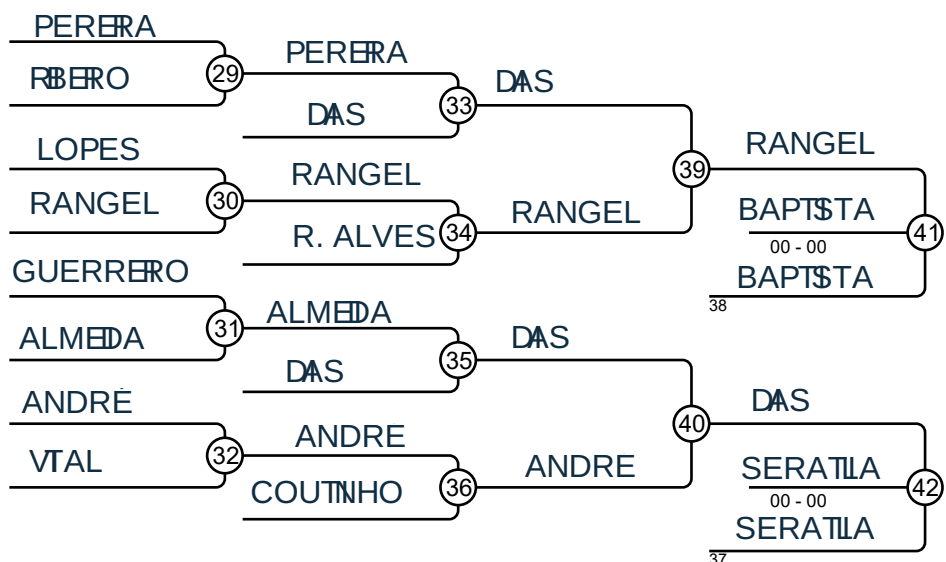

# CAMPEONATO AS NACIONAL JUNIORES

## COIMBRA – 11 DE MARÇO DE 2023

### -90 Kg

Competitors: 20

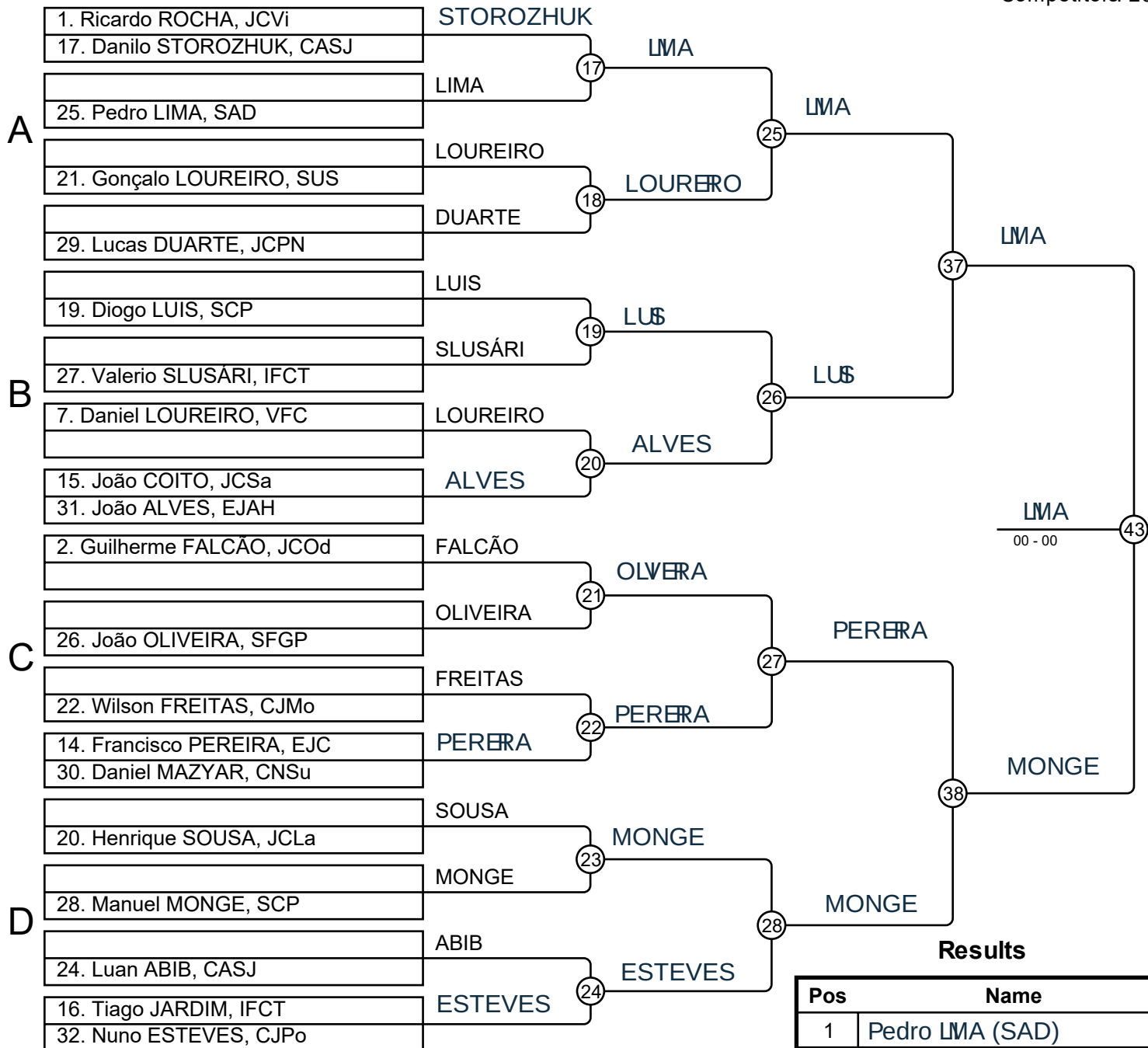

### Results

Pos	Name
1	Pedro LMA (SAD)
2	Manuel MONGE (SCP)
3	Francisco PEREIRA (EJC)
3	Diogo LUIS (SCP)
5	
5	
7	
7	

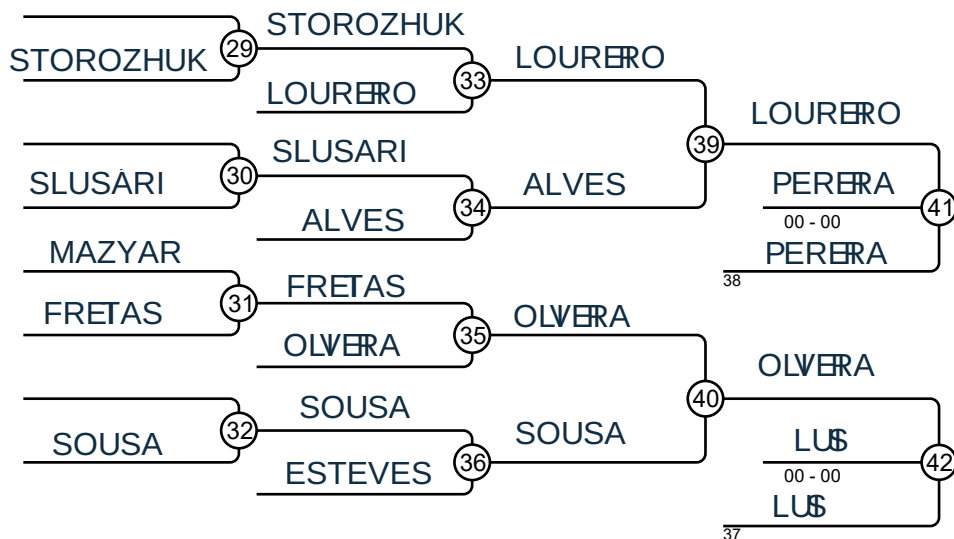

# CAMPEONATO AS NACIONAL JUNIORES

## COIMBRA – 11 DE MARÇO DE 2023

### -100 Kg

#### Competitors A

Competitors: 6

#	Name	Club	1	2	3	Wins	Pts	Pos
1	Romeu GUERREIRO	CASJ		D	V			
2	Guilherme SILVA	GRGc	V		V			
3	Carlos RODRIGUES	SLB	D	D				

#### Matches A

Match	White	Blue	Result	Time
1	Romeu GUERREIRO 1	Guilherme SILVA 2	D - V10	
3	Romeu GUERREIRO 1	Carlos RODRIGUES 3	V10 - D	
5	Guilherme SILVA 2	Carlos RODRIGUES 3	V10 - D	

#### Competitors B

#	Name	Club	4	5	6	Wins	Pts	Pos
4	Miguel JESUS	ADJF		D	D			
5	Max MZYAR	CNSu	V		V			
6	Leonardo CORDEIRO	JCJc	V	D				

#### Matches B

Match	White	Blue	Result	Time
2	Miguel JESUS 4	Max MZYAR 5	D - V10	
4	Miguel JESUS 4	Leonardo CORDEIRO 6	D - V10	
6	Max MZYAR 5	Leonardo CORDEIRO 6	V10 - D	

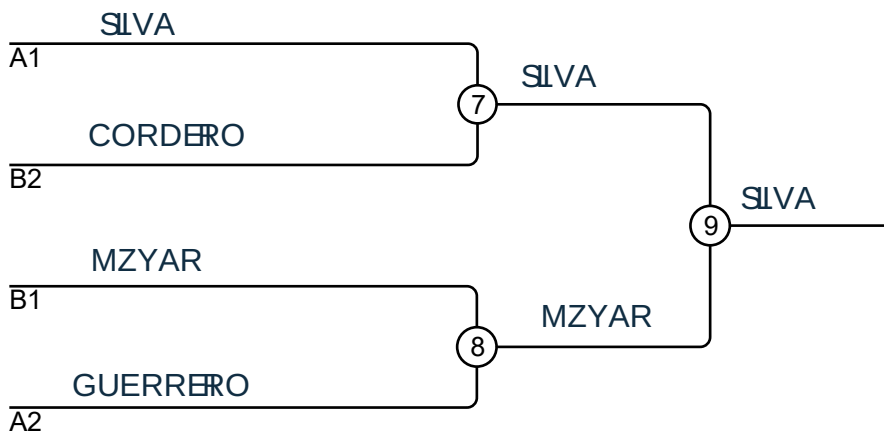

#### Results

Pos	Name
1	Guilherme SILVA (GRGc)
2	Max MZYAR (CNSu)
3	Leonardo CORDERO (JCJc)
3	Romeu GUERRERO (CASJ)



CADET EUROPEAN  
JUDO CHAMPIONSHIPS  
22 - 25 JUNE 2023

WORLD JUDO  
CHAMPIONSHIPS JUNIORS  
4-8 OCTOBER 2023



# CAMPEONATO AS NACIONAL JUNIORES

## COIMBRA – 11 DE MARÇO DE 2023

### +100 Kg

Competitors

Competitors: 3

#	Name	Club	1	2	3	Wins	Pts	Pos
1	Gabriel AZEVEDO	CPCM		D	D			
2	José CUNHA	JCMo	V		V			
3	Bruno TAVARES	SLB	V	D				

### Matches

Match	White	Blue	Result	Time
1	Gabriel AZEVEDO	1 2 José CUNHA	D-V10	
2	Gabriel AZEVEDO	1 3 Bruno TAVARES	D-V10	
3	José CUNHA	2 3 Bruno TAVARES	V10-D	

### Results

Pos	Name
1	José CUNHA (JCMo)
2	Bruno TAVARES (SLB)
3	



CADET EUROPEAN  
JUDO CHAMPIONSHIPS  
22 - 25 JUNE 2023

WORLD JUDO  
CHAMPIONSHIPS JUNIORS  
4-8 OCTOBER 2023



#	Name	Club	1	2	3	4	Wins	Pts	Pos
1	Maria BERNARDINO	EJAH		V	D	D			
2	Raquel MONIZ	CJRG	D		D	D			
3	Inês FARIA	SUS	V	V		V			
4	Iara HENRIQUES	A4JP	V	V	D				

#### Matches A

Match	White	Blue	Result	Time
1	Maria BERNARDINO	1 2 Raquel MONIZ	V10 - D	
3	Inês FARIA	3 4 Iara HENRIQUES	V10 -D	
5	Maria BERNARDINO	1 3 Inês FARIA	D - V10	
7	Raquel MONIZ	2 4 Iara HENRIQUES	D -V10	
9	Maria BERNARDINO	1 4 Iara HENRIQUES	D -V10	
11	Raquel MONIZ	2 3 Inês FARIA	D -V10	

#### Competitors B

#	Name	Club	5	6	7	8	Wins	Pts	Pos
5	Constança ALVES	SCBM		D	V	V			
6	Matilde GONÇALVES	EJAH	V		V	V			
7	Teresa SERPA	AJFC	D	D		D			
8	Madalena VASQUES	ULHT	D	D	V				

#### Matches B

Match	White	Blue	Result	Time
2	Constança ALVES	5 6 Matilde GONÇALVES	D - V10	
4	Teresa SERPA	7 8 Madalena VASQUES	D - V10	
6	Constança ALVES	5 7 Teresa SERPA	V10 -D	
8	Matilde GONÇALVES	6 8 Madalena VASQUES	V10 -D	
10	Constança ALVES	5 8 Madalena VASQUES	V10 -D	
12	Matilde GONÇALVES	6 7 Teresa SERPA	V10 - D	

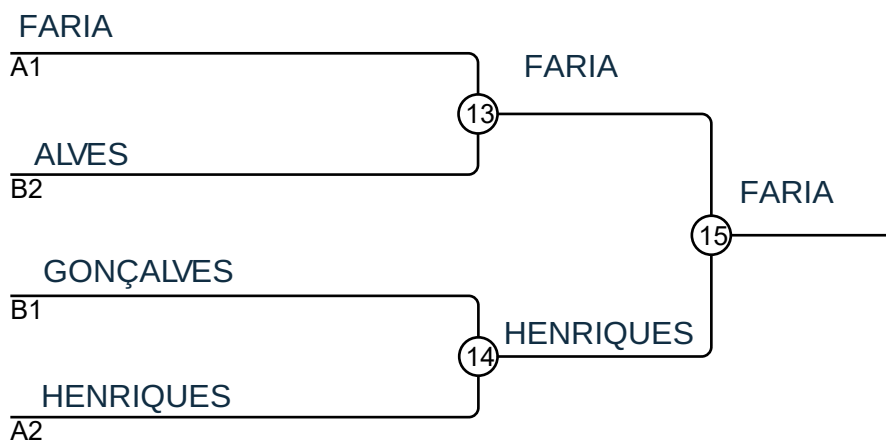

#### Results

Pos	Name
1	Inês FARIA (SUS)
2	Inês HENRIQUES (A4JP)
3	Constança ALVES (SCBM)
3	Matilde GONÇALVES (EJAH)



CADET EUROPEAN  
JUDO CHAMPIONSHIPS  
22 - 25 JUNE 2023

WORLD JUDO  
CHAMPIONSHIPS JUNIORS  
4-8 OCTOBER 2023





# CAMPEONATO AS NACIONAL JUNIORES

## COIMBRA – 11 DE MARÇO DE 2023

### -52 Kg

Competitors: 18

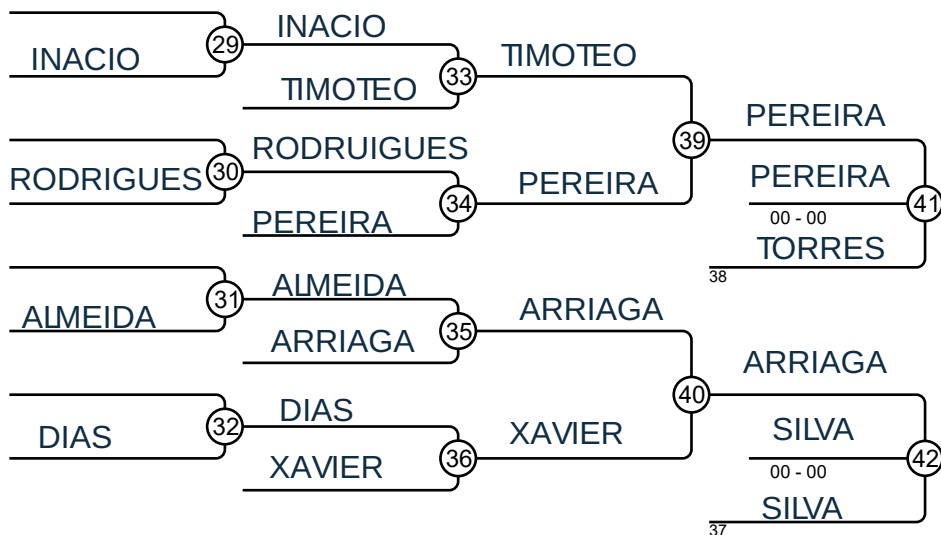
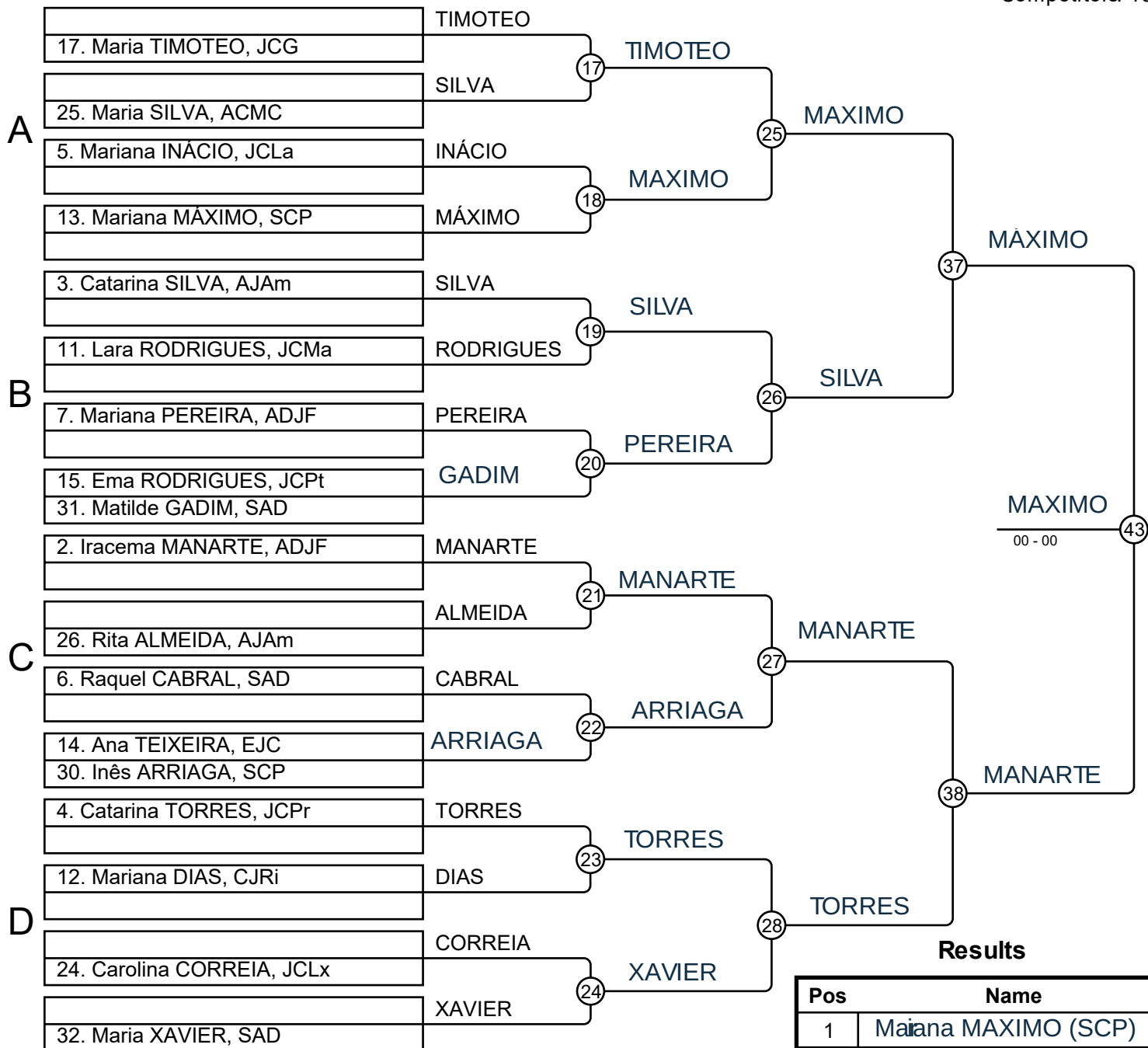

CADET EUROPEAN  
JUDO CHAMPIONSHIPS  
22 - 25 JUNE 2023

WORLD JUDO  
CHAMPIONSHIPS JUNIORS



# CAMPEONATO AS NACIONAL JUNIORES

## COIMBRA – 11 DE MARÇO DE 2023

### -57 Kg

Competitors: 17

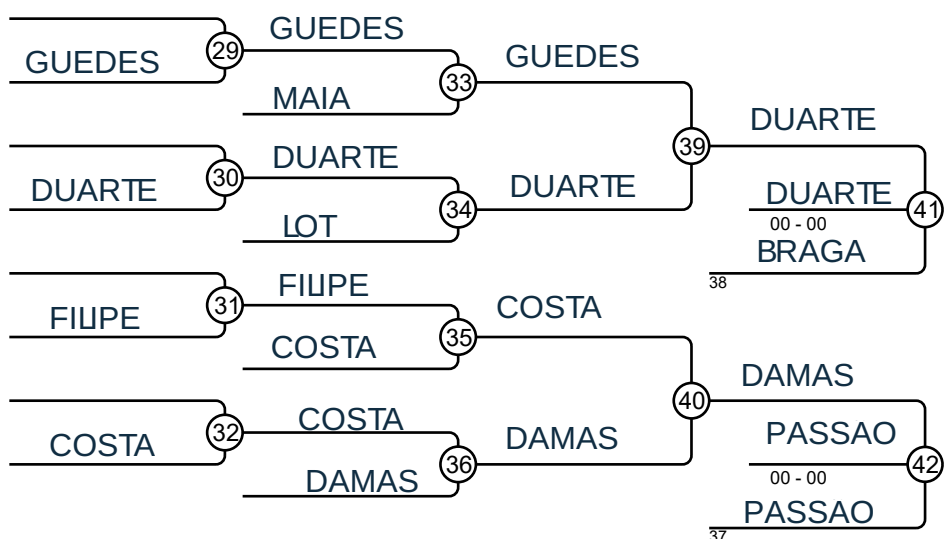
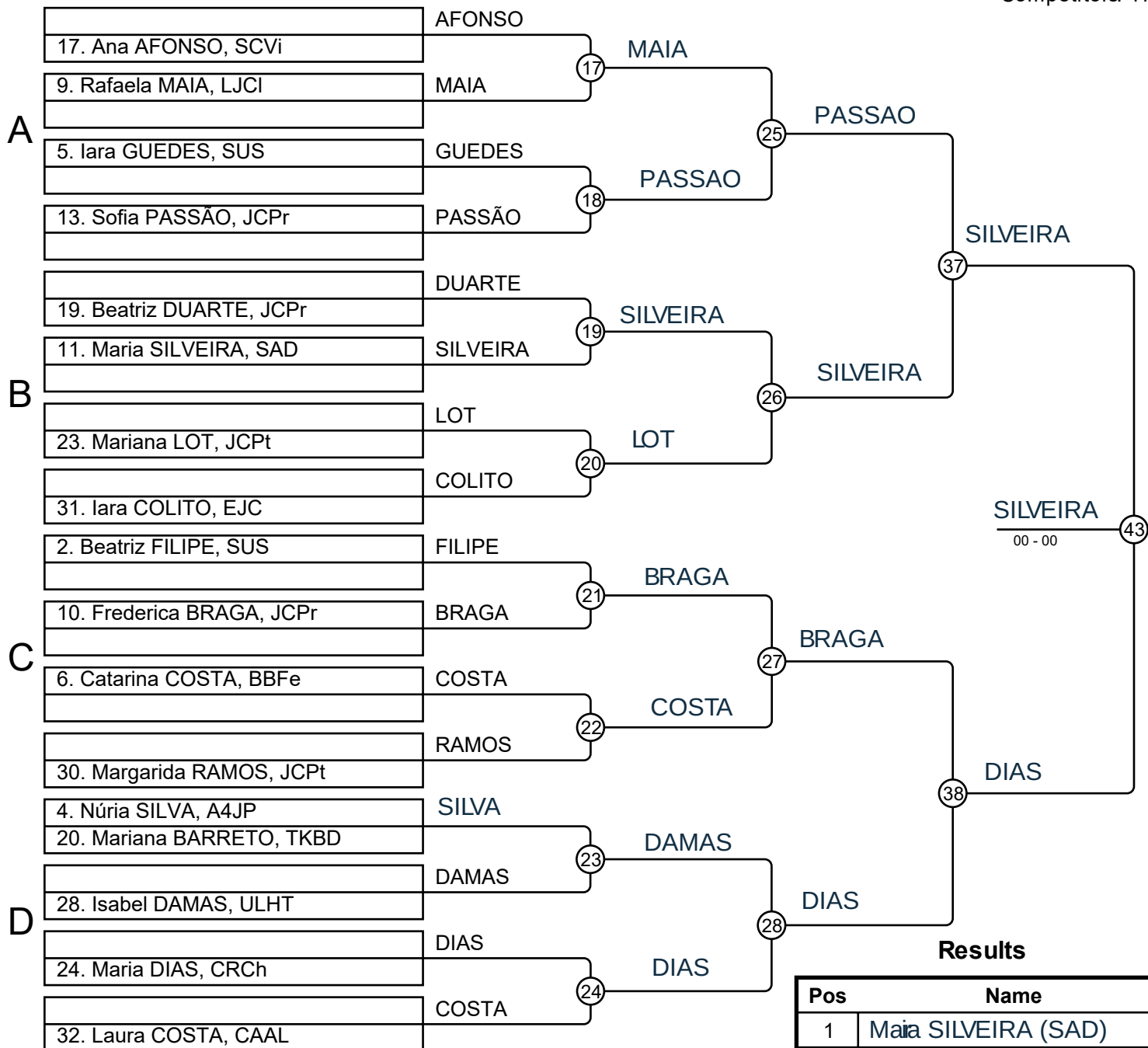

# CAMPEONATO AS NACIONAL JUNIORES

## COIMBRA – 11 DE MARÇO DE 2023

### -63 Kg

Competitors: 15

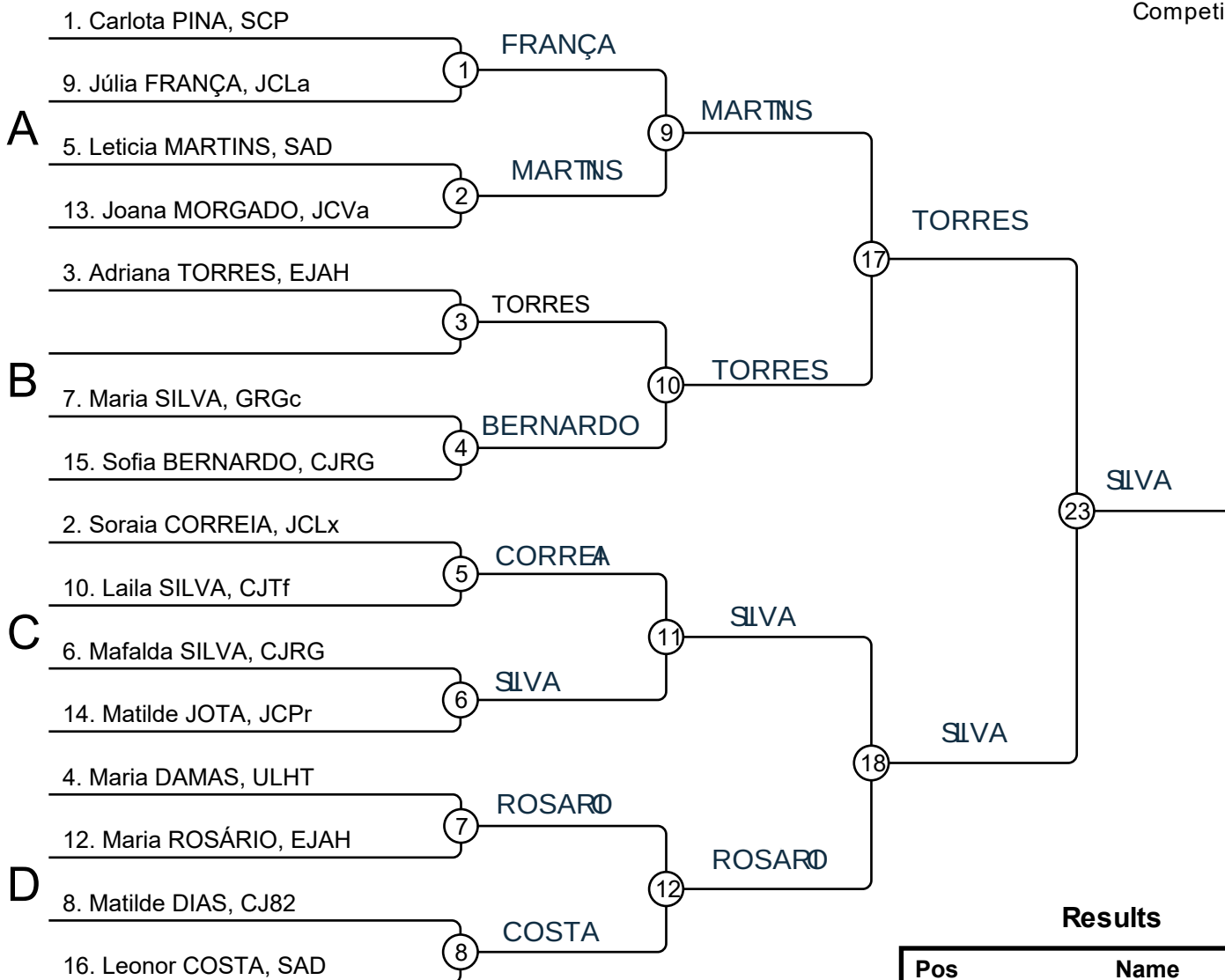

### Results

Pos	Name
1	Mafalda SILVA (CJRG)
2	Adriana TORRES (EJAH)
3	Joana MORGADO (JCVa)
3	Letícia MARTINS (SAD)
5	
5	
7	
7	

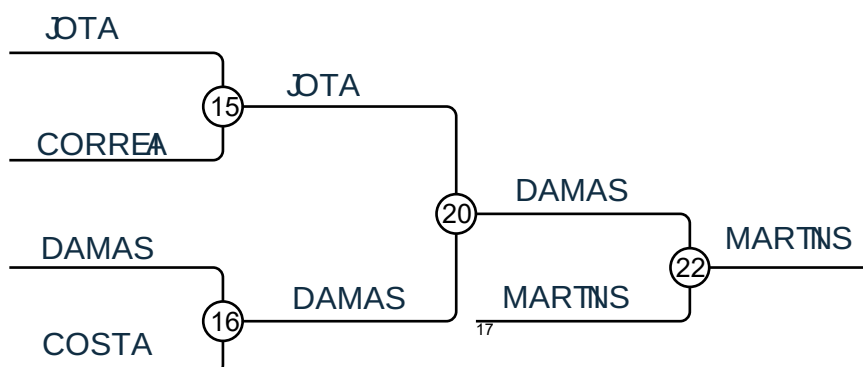
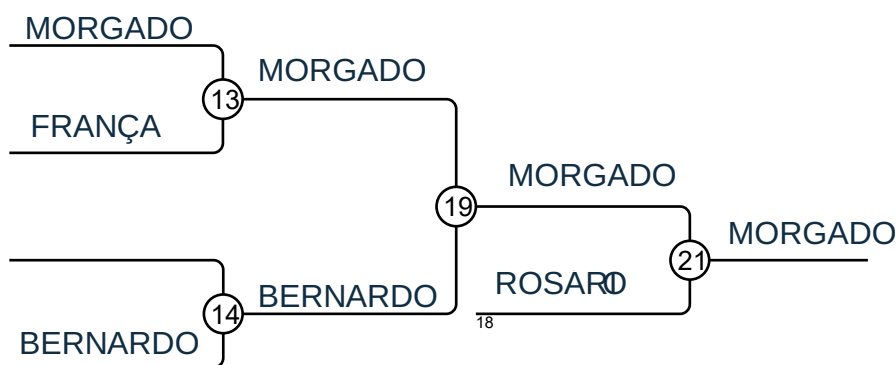

# CAMPEONATO AS NACIONAL JUNIORES

## COIMBRA – 11 DE MARÇO DE 2023

### -70 Kg

Competitors: 14



### Results

Pos	Name
1	Taís FNA (SAD)
2	Ana QUEIRÓS (Manh)
3	Luísa SANTOS (VFC)
3	Joana MORGADO (JCVC)
5	
5	
7	
7	

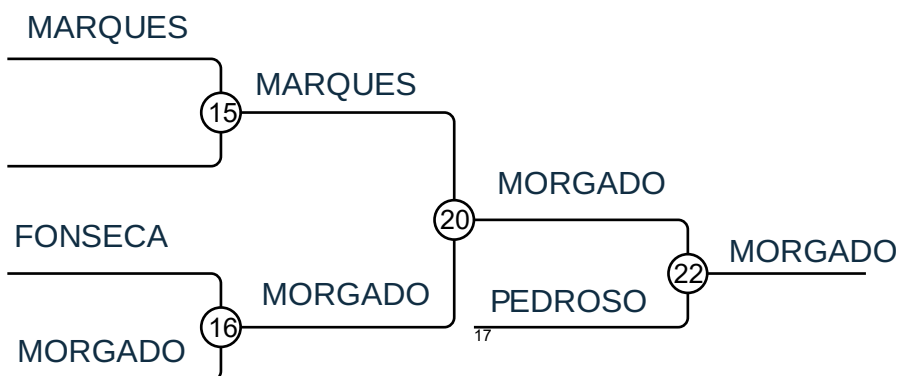
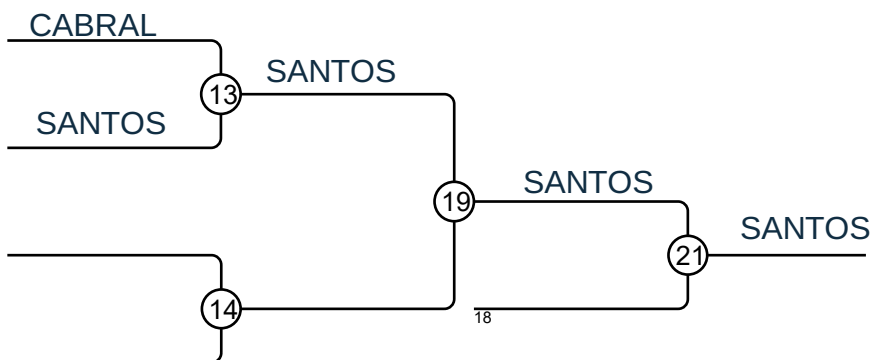

CADET EUROPEAN  
JUDO CHAMPIONSHIPS  
22 - 25 JUNE 2023

WORLD JUDO  
CHAMPIONSHIPS JUNIORS  
4-8 OCTOBER 2023



# CAMPEONATO AS NACIONAL JUNIORES

## COIMBRA – 11 DE MARÇO DE 2023

### -78 Kg

Competitors

Competitors: 3

#	Name	Club	1	2	3	Wins	Pts	Pos
1	Joana CARVALHO	JCLx		D	D			
2	Patrícia DIAS	JCPPr	V		V			
3	Mónica MENDONÇA	ADJF	V	D				

### Matches

Match	White	Blue	Result	Time
1	Joana CARVALHO	1 2 Patrícia DIAS	D - V10	
2	Joana CARVALHO	1 3 Mónica MENDONÇA	D - V10	
3	Patrícia DIAS	2 3 Mónica MENDONÇA	V10 - D	

### Results

Pos	Name
1	Patrícia DIAS (JCPPr)
2	Mónica MENDONÇA (ADJF)
3	



CADET EUROPEAN  
JUDO CHAMPIONSHIPS  
22 - 25 JUNE 2023

WORLD JUDO  
CHAMPIONSHIPS JUNIORS  
4-8 OCTOBER 2023



# CAMPEONATO AS NACIONAL JUNIORES

## COIMBRA – 11 DE MARÇO DE 2023

### +78 Kg

Competitors

Competitors: 5

#	Name	Club	1	2	3	4	5	Wins	Pts	Pos
1	Constança LOPES	SUS		D	V	D	D			
2	Maria COLITO	EJC	V		V	D	V			
3	Mariana NUNES	ADJF	D	D		D	D			
4	Rosa MANÉ	JCAI	V	V	V		V			
5	Ana SILVA	Manh	V	D	V	D				

### Matches

Match	White	Blue	Result	Time
1	Rosa MANÉ	Ana SILVA	V10 - D	
2	Constança LOPES	Maria COLITO	D - V10	
3	Mariana NUNES	Rosa MANÉ	D - V10	
4	Constança LOPES	Ana SILVA	D - V10	
5	Maria COLITO	Mariana NUNES	V10 - D	
6	Constança LOPES	Rosa MANÉ	D - V10	
7	Mariana NUNES	Ana SILVA	D - V10	
8	Maria COLITO	Rosa MANÉ	D - V10	
9	Constança LOPES	Mariana NUNES	V10 - D	
10	Maria COLITO	Ana SILVA	V10 - D	

### Results

Pos	Name
1	Rosa MANE (JCAI)
2	Maria COLTO (EJC)
3	Ana SILVA (Manh)
4	Constança LOPES (SUS)
5	



CADET EUROPEAN  
JUDO CHAMPIONSHIPS  
22 - 25 JUNE 2023

WORLD JUDO  
CHAMPIONSHIPS JUNIORS  
4-8 OCTOBER 2023







Federação Portuguesa  
de **Judo**

CAMPEONATO AS NACIONAL DE JUNIORES

COIMBRA – 11 DE MARÇO DE 2023

**MEDALHEIRO**

CLASS.	CLUBE	1º Class.	2º Class.	3º Class.	TOTAL
1º	SUS	3	1	1	5
2º	SAD	3	1	1	5
3º	SCP	2	1	2	5
4º	JCPr	1		2	3
5º	AAC	1		1	2
6º	CJRG	1			1
6º	GRGc	1			1
6º	JCAI	1			1
6º	JCMo	1			1
10º	ADJF		2	1	3
11º	SLB		2		2
12º	ACMC		1	1	2
12º	EJAH		1	1	2
12º	Manh		1	1	2
12º	EJC		1	1	2
16º	CNSu		1		1
16º	A4JP		1		1
16º	CRCh		1		1
19º	ULHT			2	2
20º	VFC			1	1
20º	JCVC			1	1
20º	JCPt			1	1
20º	JCVa			1	1
20º	JCjc			1	1
20º	CASJ			1	1
20º	SCBM			1	1
20º	AJAm			1	1
20º	JCPN			1	1